

● Features

- Low forward voltage drop, high current capability
- Ideal for printed circuit board
- MSL: Level 1
- Forward Current - 50A
- Epoxy meets UL 94 V-0 flammability rating
- Solder dip 275 °C max. 7 s, per JESD 22-B106

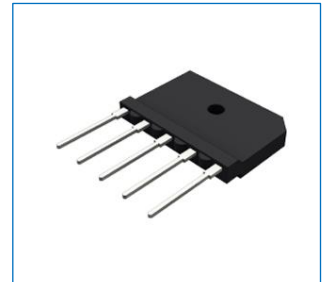

● Mechanical Data

- Case: SGBJ package

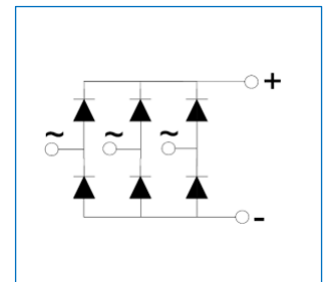

● Maximum Ratings (Ta=25°C Unless otherwise specified)

PARAMETER	SYMBOL	WSGBJ 5006	WSGBJ 5008	WSGBJ 5010	WSGBJ 5012	WSGBJ 5016	UNIT
Maximum repetitive peak reverse voltage	V _{RRM}	600	800	1000	1200	1600	V
Maximum RMS voltage	V _{RMS}	420	560	700	840	1120	V
Maximum DC blocking voltage	V _{DC}	600	800	1000	1200	1600	V
Maximum average forward rectified current (with heatsink)	I _{F(AV)}	50					A
Peak forward surge current 8.3ms single half-sine wave superimposed on rated load	I _{FSM}	500					A
Rating for fusing (t<8.3ms)	I ² t	1037					A ² s
Operating and Storage temperature range	T _J , T _{STG}	-55 ~ +150					°C
Mounting torque @Recommend torque: 5kg·cm	Tor	8					kg·cm

● Electrical Characteristics(Ta=25°C Unless otherwise specified)

PARAMETER	SYMBOL	WSGBJ 5006	WSGBJ 5008	WSGBJ 5010	WSGBJ 5012	WSGBJ 5016	UNIT
Maximum instantaneous forward voltage at I _F =25A	V _F	1.1					V
Maximum DC reverse current at rated DC blocking voltage	T _J =25°C	5					μA
	T _J =125°C	500					
Typical Junction Capacitance at V _R =4V, f=1MHz	C _j	180					pF
Between Junction to Case (with heatsink)	R _{θJ-C}	0.8					°C/W

● Typical Characteristics

FIG.1 Forward Current Derating Curve

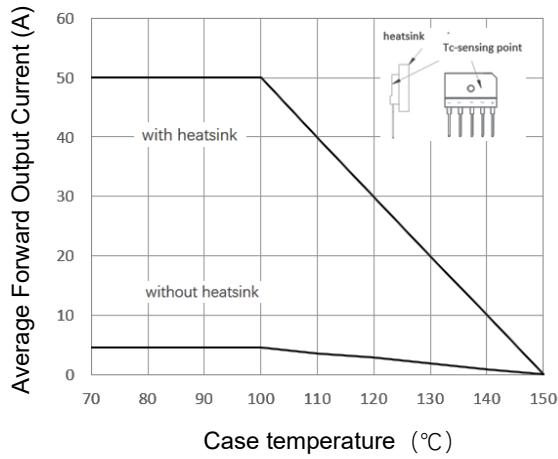

FIG. 2 Forward Surge Current Capability

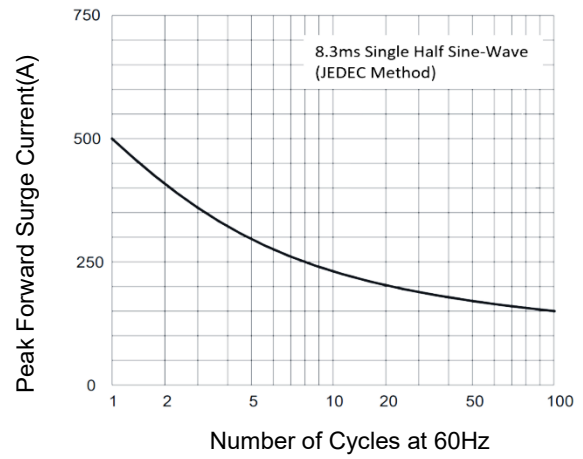

FIG. 3 Typical Forward Characteristics

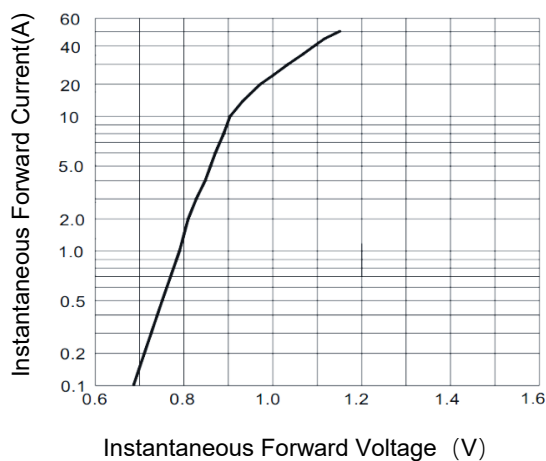
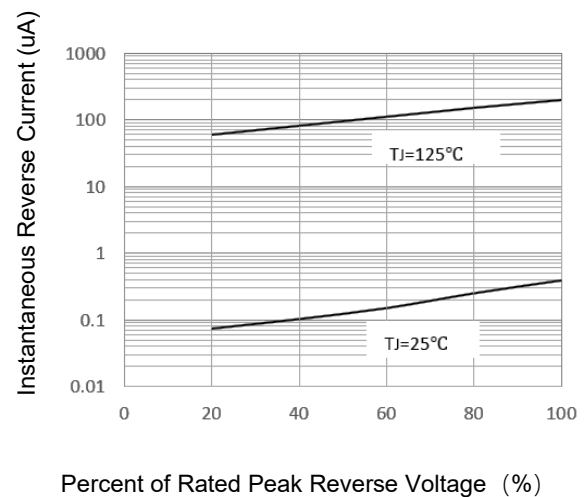
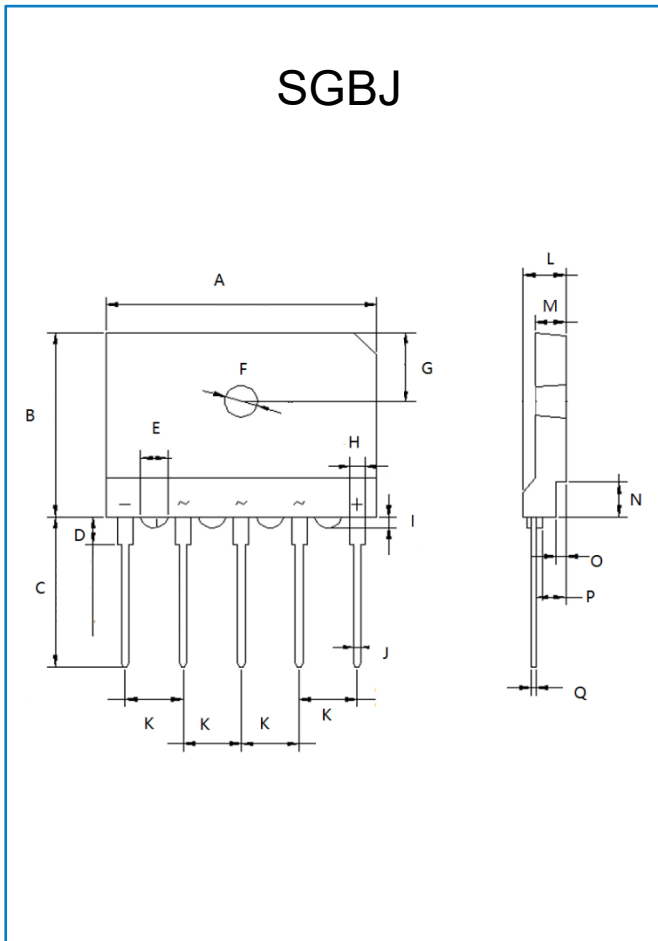

FIG.4 Typical Reverse Characteristics



Note: The above typical parameters or typical characteristics are only indicative and do not make specific guarantees. If detailed values are required, additional communication and provision are required.

● **Outline Drawing**



SGBJ		
Symbol	Dimensions In Millimeters	
	Min	Max
A	34.60	35.40
B	24.70	25.30
C	20.20	20.60
D	3.70	3.80
E	3.40	3.60
F	4.10	4.30
G	9.00	9.60
H	1.90	2.10
I	1.40	1.60
J	0.90	1.10
K	7.40	7.60
L	5.40	5.60
M	3.90	4.10
N	4.60	4.80
O	1.20	1.40
P	3.70	3.90
Q	0.60	0.80

Contact Information

No.1001, Shiwang(7) Road, Pudong District, Shanghai, P.R.China.201207

Tel: 86-21-50310888 Fax: 86-21-50757680 Email: market@way-on.com

WAYON website: <http://www.way-on.com>

For additional information, please contact your local Sales Representative.

WAYON ® is registered trademark of Wayon Corporation.

Product Specification Statement

1. The product specification aims to provide users with a reference regarding various product parameters, performance, and usage. It presents certain aspects of the product's performance in graphical form and is intended solely for users to select product and make product comparisons, enabling users to better understand and evaluate the characteristics and advantages of the product. It does not constitute any commitment, warranty, or guarantee.

2. The product parameters described in the product specification are numerical values, characteristics, and functions obtained through actual testing or theoretical calculations of the product in an independent or ideal state. Due to the complexity of product applications and variations in test conditions and equipment, there may be slight fluctuations in parameter test values. WAYON shall not guarantee that the actual performance of the product when installed in the customer's system or equipment will be entirely consistent with the product specification, especially concerning dynamic parameters. It is recommended that users consult with professionals for product selection and system design. Users should also thoroughly validate and assess whether the actual parameters and performance when installed in their respective systems or equipment meet their requirements or expectations. Additionally, users should exercise caution in verifying product compatibility issues, and WAYON assumes no responsibility for the application of the product.

3. WAYON strives to provide accurate and up-to-date information to the best of our ability. However, due to technical, human, or other reasons, WAYON cannot guarantee that the information provided in the product specification is entirely accurate and error-free. WAYON shall not be held responsible for any losses or damages resulting from the use or reliance on any information in these product specifications. WAYON reserves the right to revise or update the product specification and the products at any time without prior notice, and the user's continued use of the product specification is considered an acceptance of these revisions and updates. Prior to purchasing and using the product, users should verify the above information with WAYON to ensure that the product specification is the most current, effective, and complete. If users are particularly concerned about product parameters, please consult WAYON in detail or request relevant product test reports. Any data not explicitly mentioned in the product specification shall be subject to separate agreement.

4. Users are advised to pay attention to the parameter limit values specified in the product specification and maintain a certain margin in design or application to ensure that the product does not exceed the parameter limit values defined in the product specification. This precaution should be taken to avoid exceeding one or more of the limit values, which may result in permanent irreversible damage to the product, ultimately affecting the quality and reliability of the system or equipment.

5. The design of the product is intended to meet civilian needs and is not guaranteed for use in harsh environments or precision equipment. It is not recommended for use in systems or equipment such as medical devices, aircraft, nuclear power, and similar systems, where failures in these systems or equipment could reasonably be expected to result in personal injury. WAYON shall assume no responsibility for any consequences resulting from such usage.

6. Users should also comply with relevant laws, regulations, policies, and standards when using the product specification. Users are responsible for the risks and liabilities arising from the use of the product specification and must ensure that it is not used for illegal purposes. Additionally, users should respect the intellectual property rights related to the product specification and refrain from infringing upon any third-party legal rights. WAYON shall assume no responsibility for any disputes or controversies arising from the above-mentioned issues in any form.