

1. General Description

The WR0114 is a high precision, low dropout, ultra-low quiescent current CMOS linear regulator. The WR0114 provides 150 mA of output current with an input voltage range of 2.2 V to 5.5 V and an output range of 1.2 V to 3.3 V, allowing the device to be used in a variety of applications. The low dropout voltage and ultra-low quiescent current make this family of devices ideal for a wide range of battery wearable devices. All device versions have thermal shutdown and current limiting to ensure safety. These devices offer a new level of cost effectiveness for cell phones, notebooks and laptops, and other portable devices.

The WR0114 regulators are available in standard SOT23-3, SOT23-5, and DFN1x1-4 packages. The standard products are lead-free and halogen-free.

2. Features

- Input Voltage: 2.2V~5.5V
- Output Voltage: 1.2V~3.3V
- Ultra-Low Quiescent Current: 0.7 μ A (Typ.)
- High Output Voltage Accuracy: $\pm 1\%$
- Operating Temperature: -40° C to 85° C
- Recommended Capacitor: 1 μ F

3. Applications

- Cameras, Image Sensors and Camcorders
- Portable Communication Equipment
- Battery Powered Equipment

4. Typical Application

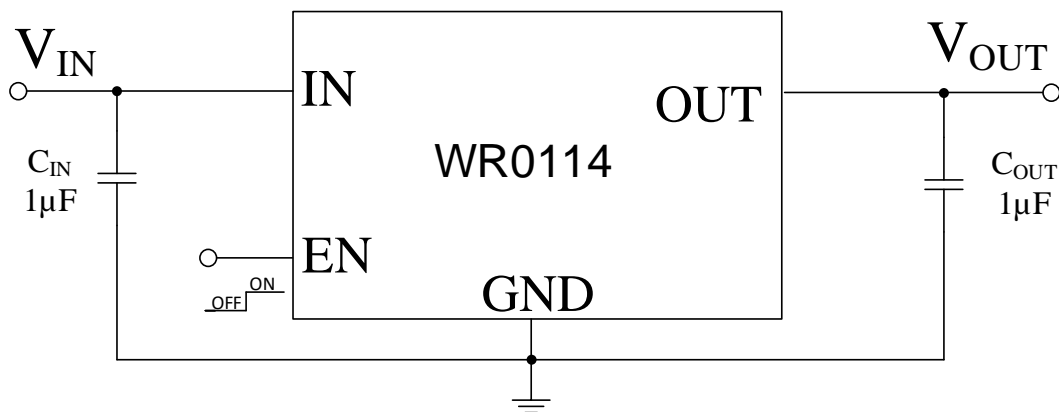

5. Pin Configuration

(Top View)

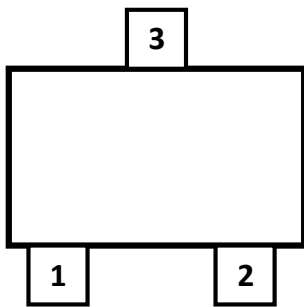

SOT23-3

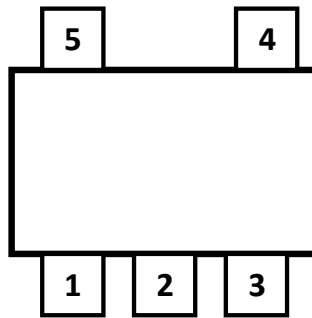

SOT23-5

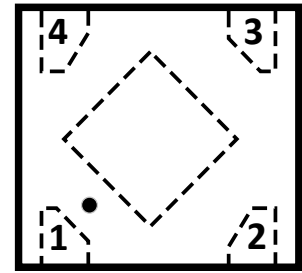

DFN1×1-4

6. Pin Description

PIN NUMBER			PIN NAME	I/O	PIN FUNCTION
SOT23-3	SOT23-5	DFN-4			
3	1	4	IN	I	Input voltage supply. Bypass with a typical 1μF capacitor to GND. Place the input capacitor as close to the IN and GND pins of the device as possible.
1	2	2	GND	-	Common ground.
-	3	3	EN	I	Enable input. Active High. EN includes a small pull-up current source, nominally 0.1μ A.
-	4	-	NC	-	No internal electrical connection.
2	5	1	OUT	O	Regulated output voltage. A low equivalent series resistance (ESR) capacitor is required from OUT to ground for stability. 1μF or greater capacitor is recommended. Place the output capacitor as close to the OUT and GND pins of the device as possible.

7. Absolute Maximum Ratings

Over operating free-air temperature range (unless otherwise noted)^[1]

PARAMETER		RATING	UNIT
Input voltage range		-0.3 to 6.0	V
EN Input voltage range		-0.3 to V_{IN}	
Output voltage range		-0.3 to V_{IN}	
Power Dissipation $P_{D(MAX)}$ @ $T_A = 25^\circ\text{C}$	SOT23-3	681	mW
	SOT23-5	1046	
	DFN-4	664	
Thermal resistance ^{[2] [4]} $R_{\theta JA}$	SOT23-3	183.3	$^\circ\text{C}/\text{W}$
	SOT23-5	119.4	
	DFN-4	188.1	
Thermal resistance ^{[2] [3]} $R_{\theta JB}$	SOT23-3	148.1	
	SOT23-5	89.09	
	DFN-4	154.8	
Top Thermal resistance ^{[2] [3]} $R_{\theta JC}$	SOT23-3	119.2	
	SOT23-5	48.9	
	DFN-4	121.4	
Bottom Thermal resistance ^[2] ^[3] $R_{\theta JC}$	SOT23-3	31.75	
	SOT23-5	26.36	
	DFN-4	46.54	
Junction Temperature		150	$^\circ\text{C}$
Lead Temperature Range		260	
Storage Temperature Range		-55 to 150	
ESD susceptibility	HBM	± 2000	V

NOTE[1]: Greater than these given values, the device will be damaged.

NOTE[2]: Measured on 2cm x 2cm 2-layer FR4 PCB board, 1 oz copper, no via holes on GND copper.

NOTE[3]: Measured according to JEDEC board specification. Detailed description of the board can be found in JESD51-7.

NOTE[4]: Power dissipation is calculate by $P_{D(MAX)} = (T_J - T_A) / R_{\theta JA}$

8. Recommended Operating Conditions

PARAMETER	RATING	UNIT
Input voltage range	2.2 to 5.5	V
Nominal output voltage range	0 to 3.3	
Output current	0 to 150	mA
Input capacitor	1	μF
Output capacitor	1	
Operating temperature range	-40 to 85	$^\circ\text{C}$

9. Electrical Characteristics

($V_{IN}=V_{OUT(NOMINAL)}+1V$, $C_{IN}=C_{OUT}=1\mu F$, $T_A=25^\circ C$, unless otherwise noted)

SYMBOL	PARAMETER	TEST CONDITIONS	MIN	TYP.	MAX	UNIT
V_{OUT}	Output Voltage Range	$0 \leq I_{OUT} \leq 150mA$	0.99 V_{OUT}	V_{OUT}	1.01 V_{OUT}	V
V_{DO}	Dropout Voltage ^{[1] [2]}	$I_{OUT}=150mA$	$V_{OUT}=1.8V$		280	mV
			$V_{OUT}=2.8V$		180	
			$V_{OUT}=3.0V$		170	
			$V_{OUT}=3.3V$		160	
LNR	Line Regulation	$V_{OUT}+1V < V_{IN} \leq 5.5V$, $I_{OUT}=1mA$		0.05	0.20	%/V
LDR	Load Regulation ^[3]	$0mA < I_{OUT} \leq 150mA$, $V_{IN}=V_{OUT}+1$		15		mV
V_{IH}	EN logic high voltage	$V_{IN}=5.5V$, $I_{OUT}=1mA$	1.2			V
V_{IL}	EN logic low voltage	$V_{IN}=5.5V$, $I_{OUT}=0mA$			0.4	V
I_{OUT}	Maximum output current in the accuracy range	$V_{IN}=V_{OUT(NOMINAL)}+1$	150			mA
I_{LIM}	Output current limit	$V_{IN}=V_{OUT(NOMINAL)}+1$		250		mA
I_{SHORT}	Short Current	$V_{IN}=V_{OUT(NOMINAL)}+1$, V_{OUT} Short to GND		225		mA
I_Q	Quiescent Current	$V_{OUT}=1.5V$, $I_{OUT}=0mA$		0.7	1	μA
I_{EN}	EN Input leakage	$V_{EN}=5.5V$		100		nA
I_{SHDN}	Shut-down Current	$V_{EN}=0V$		0.1	0.5	μA
V_{NO}	Output noise voltage	$V_{IN}=5.0V$, $f=10Hz$ to $1MHz$, $C_{OUT}=1\mu F$, $I_{OUT}=1mA$, $V_{OUT}=1.8V$		95		μV_{RMS}
R_{DIS}	Output Discharge Resistance	$V_{IN}=5.5V$, $V_{EN}=0V$		140		Ω

SYMBOL	PARAMETER	TEST CONDITIONS	MIN	TYP.	MAX	UNIT
PSRR	Power Supply Ripple Rejection	$V_{IN} = (V_{OUT} + 1V)_{DC} + 200mV_{p-p}$, $f=1kHz$, $I_{OUT} = 10mA$		50		dB
T_{SD}	Thermal Shutdown Temperature	Temperature Increasing from $T_J = +25^{\circ}C$		175		$^{\circ}C$
ΔT_{SD}	Thermal Shutdown Hysteresis	Temperature Falling from T_{SD}		20		$^{\circ}C$

NOTE[1]: VDO is measured for devices with $V_{OUT(nom)} \geq 1.8V$.

NOTE[2]: Characterized when V_{OUT} falls $V_{OUT} * 3\%$ below the regulated voltage.

NOTE[3]: The Load regulation is measured by using pulse techniques with the duty cycle $< 5\%$.

NOTE[4]: Specifications in bold type are limited to $-40^{\circ}C \leq T_A \leq +85^{\circ}C$. Limits over temperature are guaranteed by design, but not tested in production..

10. Typical Performance Characteristics

($T_A = -40$ to 85°C , $V_{IN} = V_{OUT} + 1\text{V}$, $C_{IN} = C_{OUT} = 1\mu\text{F}$, unless otherwise noted)

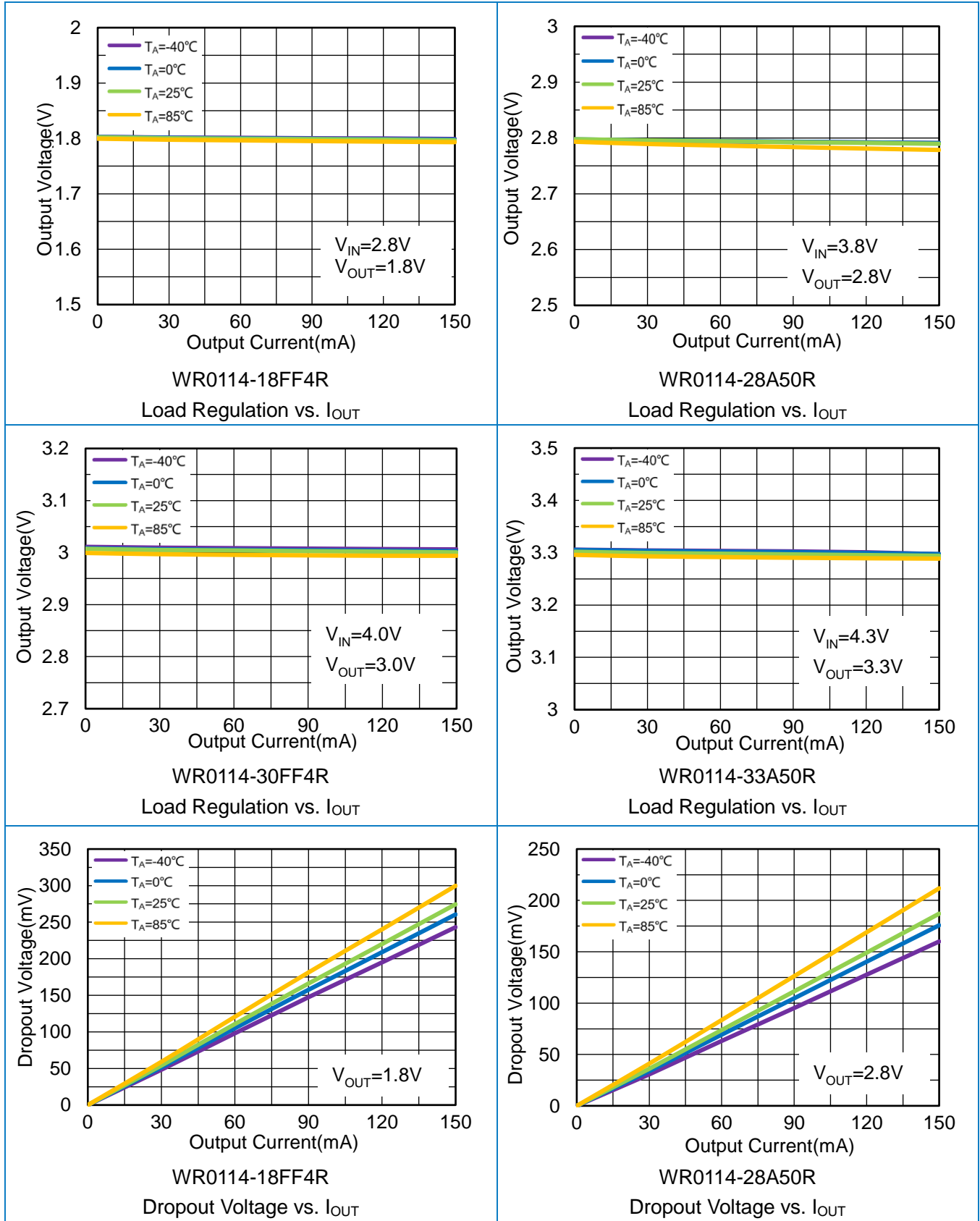

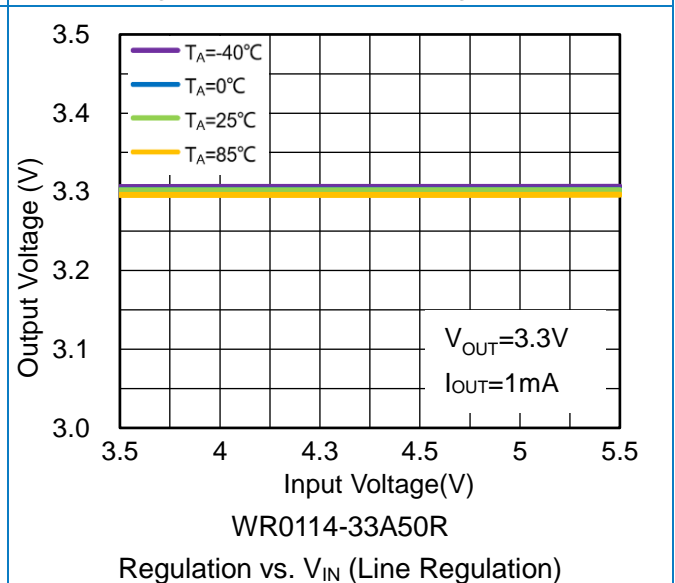
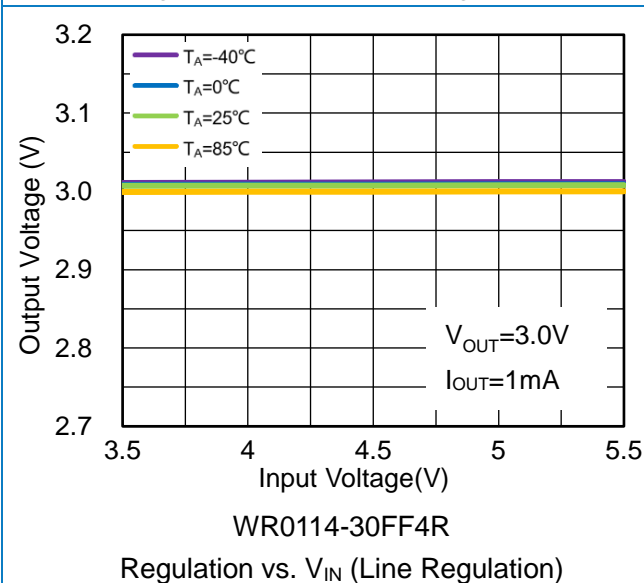
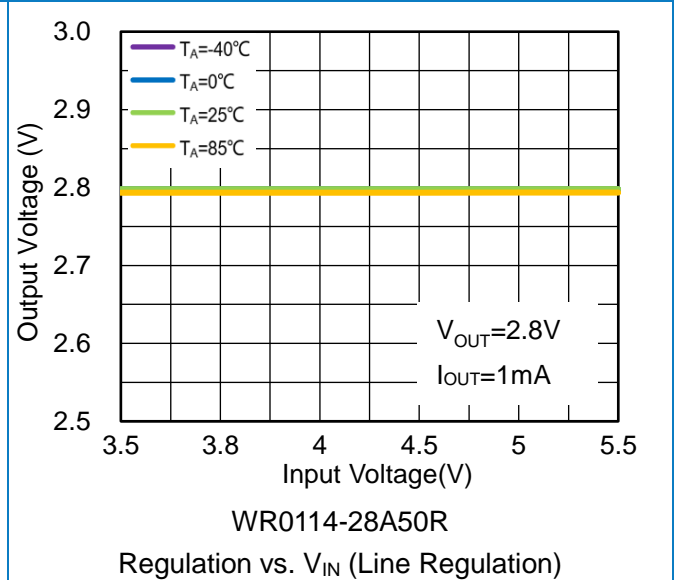
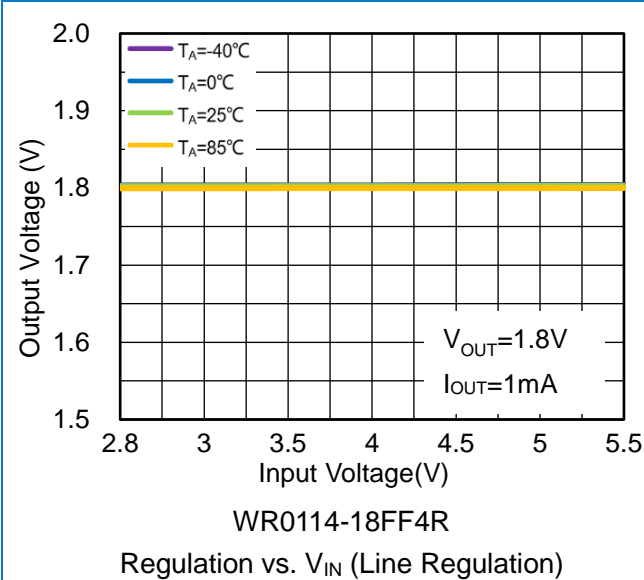
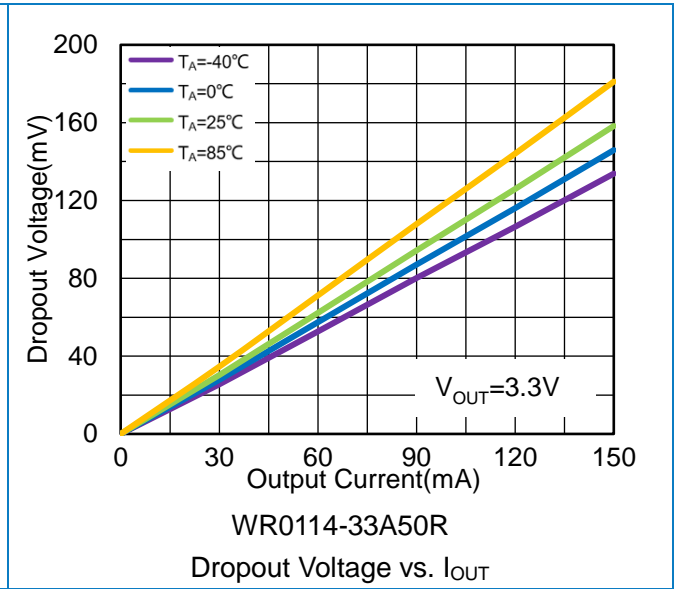
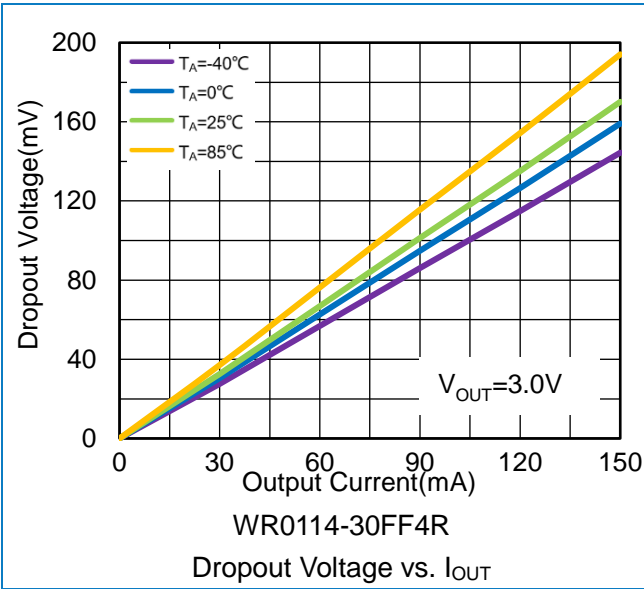

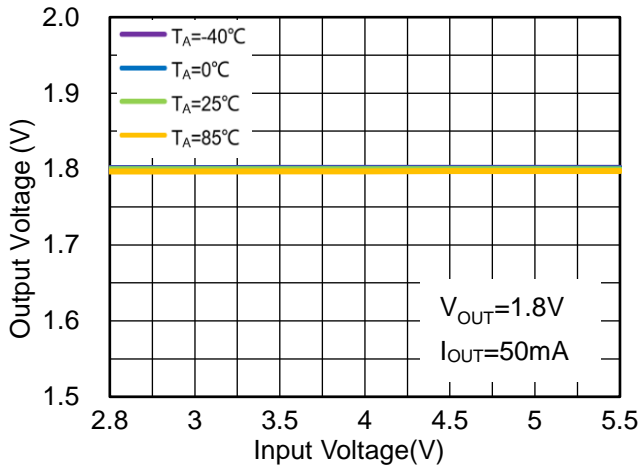

WR0114-18FF4R

Regulation vs. V_{IN} (Line Regulation)

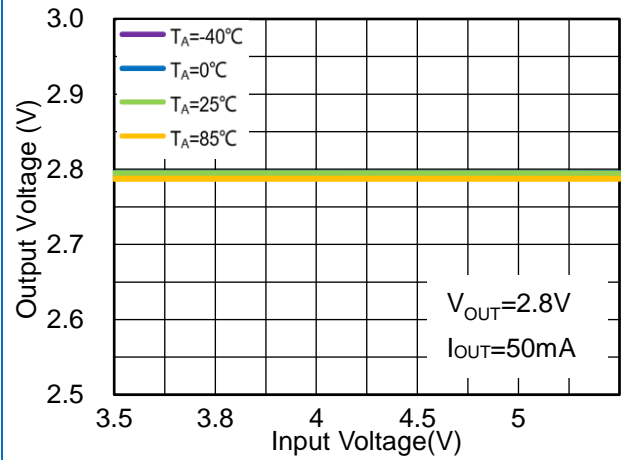

WR0114-28A50R

Regulation vs. V_{IN} (Line Regulation)

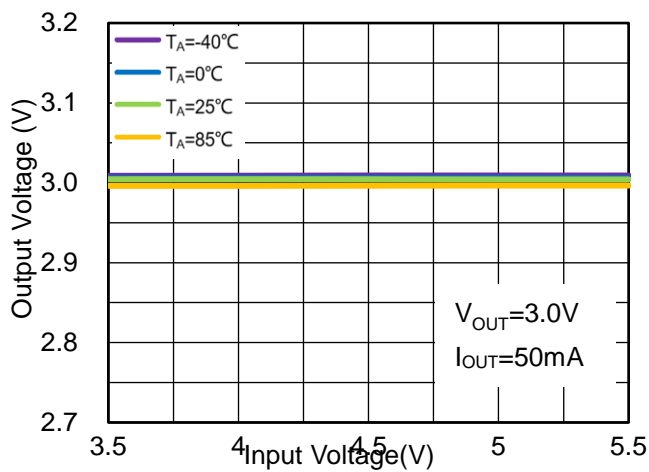

WR0114-30FF4R

Regulation vs. V_{IN} (Line Regulation)

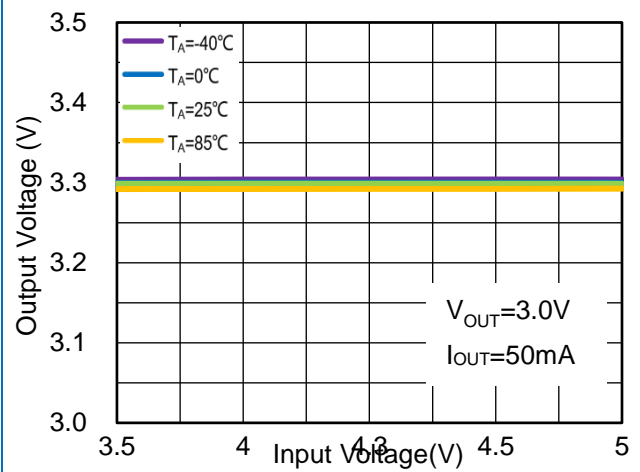

WR0114-33A50R

Regulation vs. V_{IN} (Line Regulation)

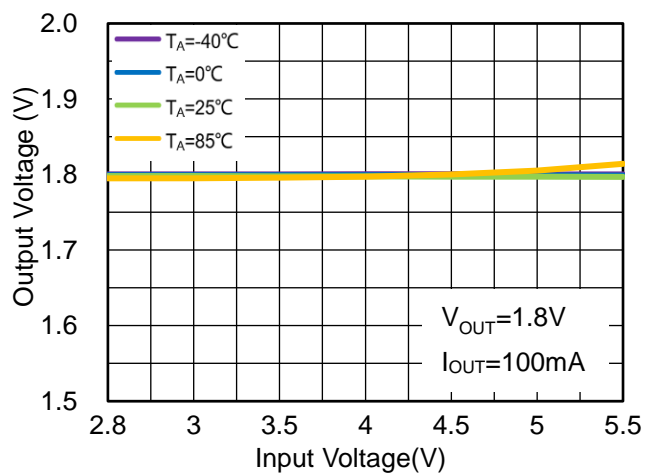

WR0114-18FF4R

Regulation vs. V_{IN} (Line Regulation)

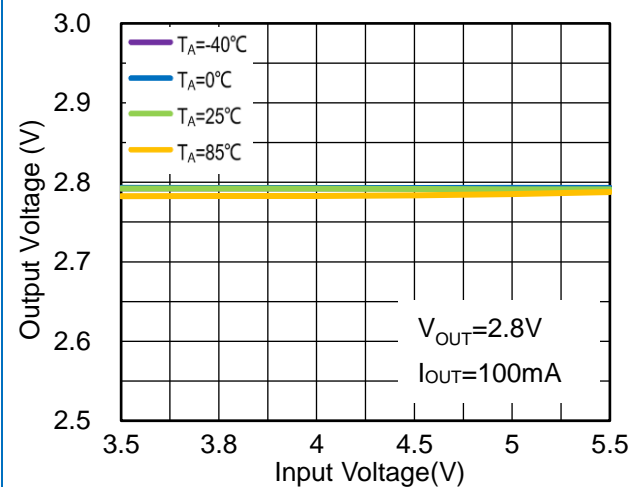

WR0114-28A50R

Regulation vs. V_{IN} (Line Regulation)

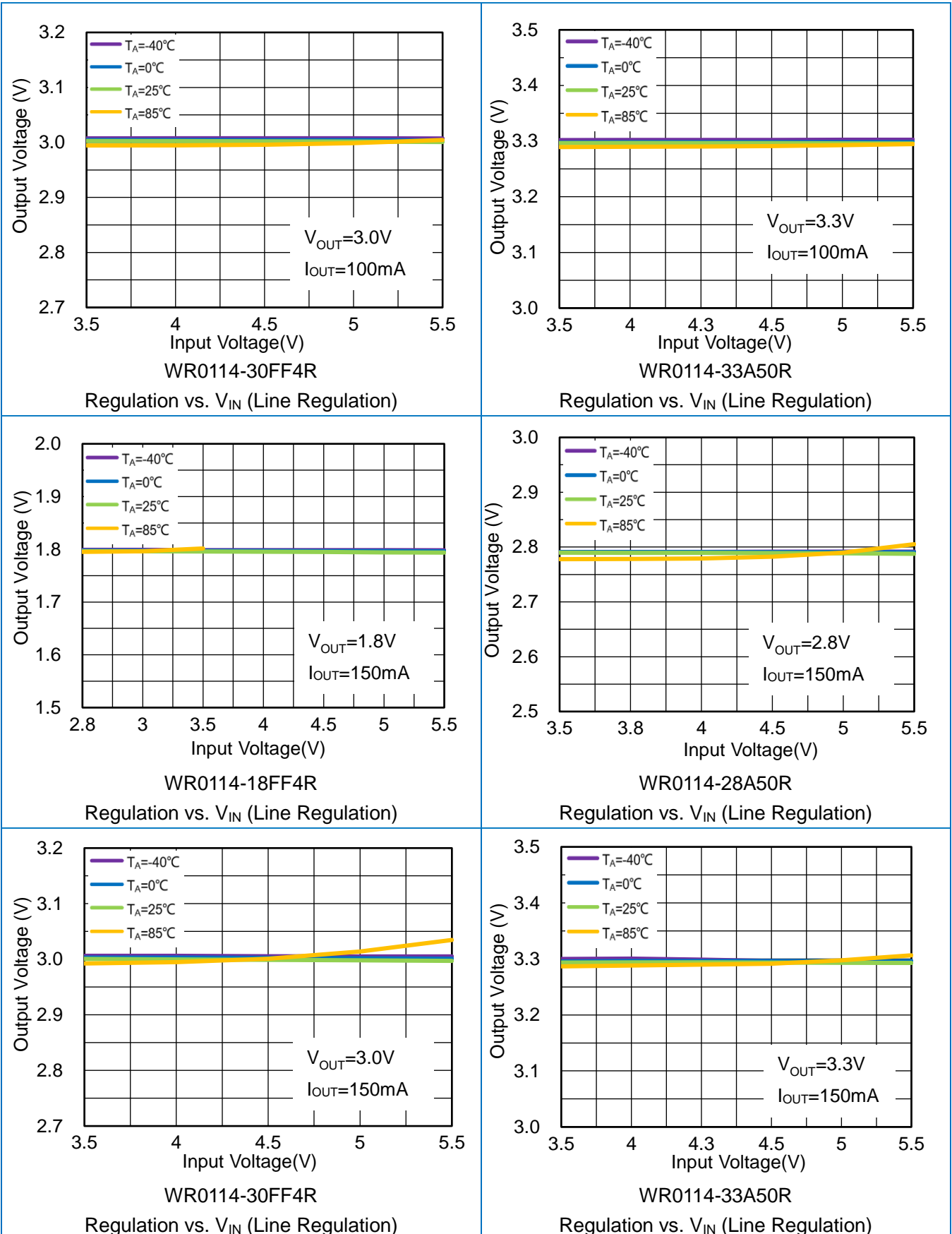

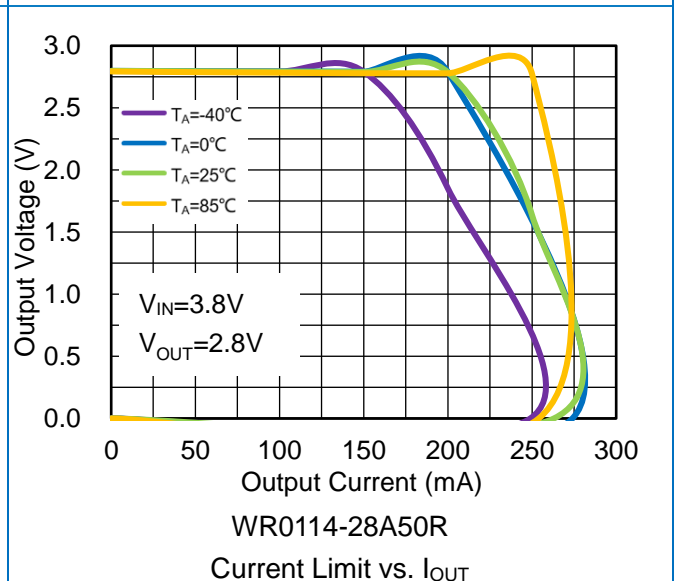
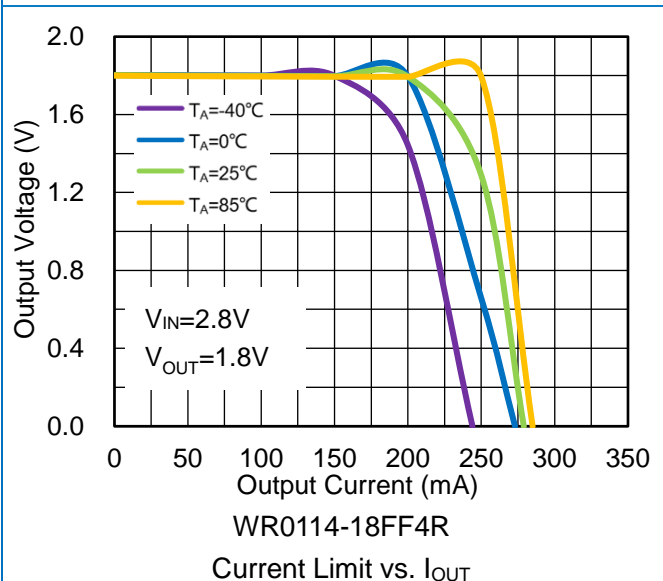
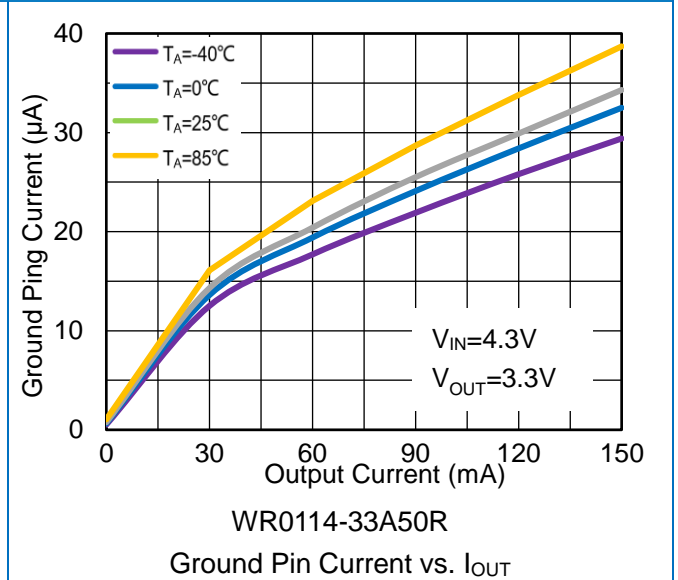
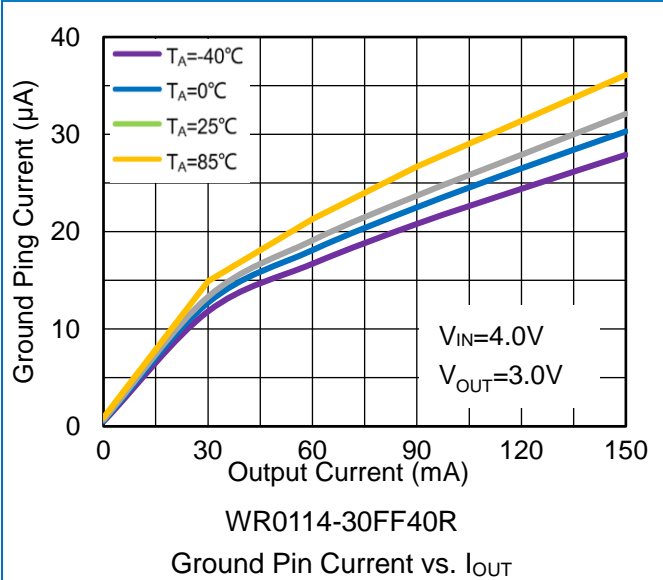
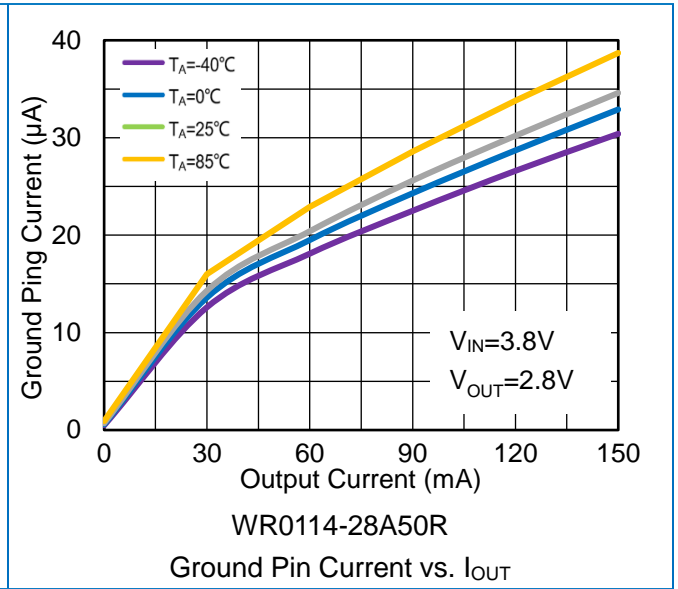
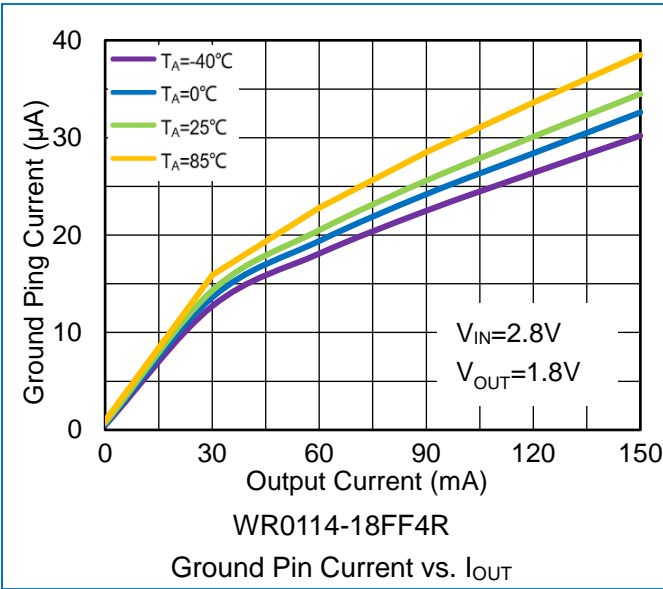

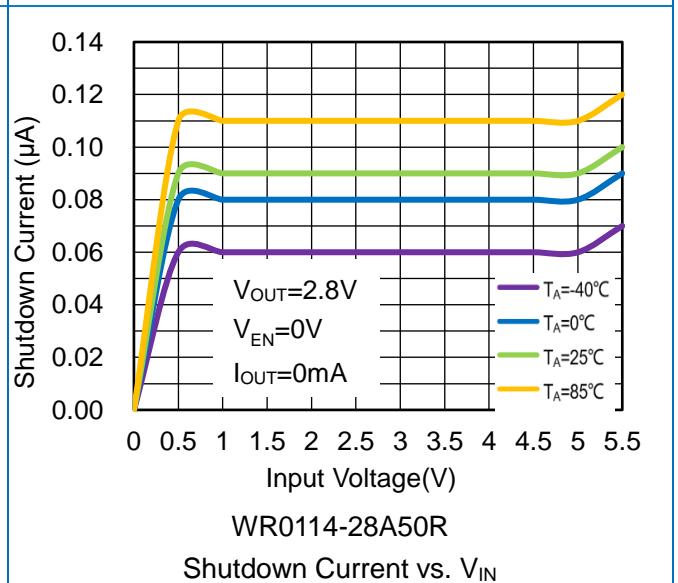
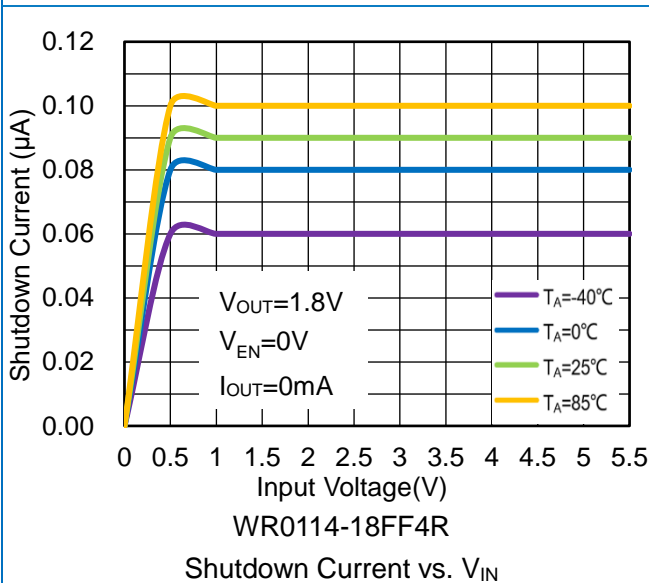
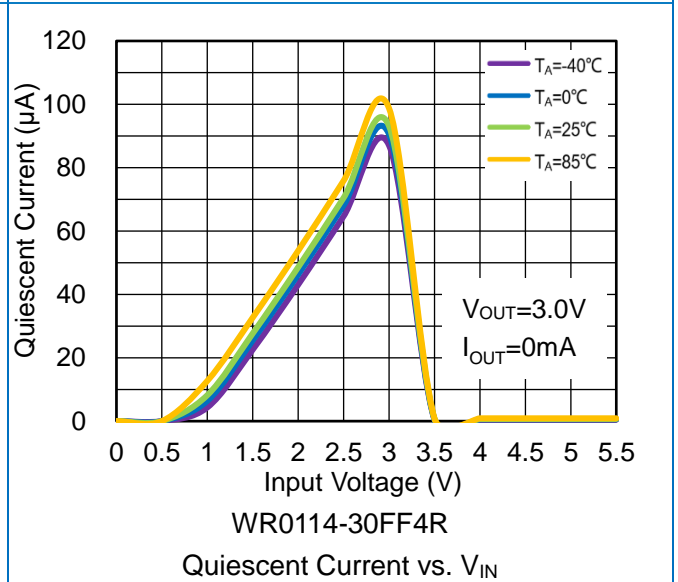
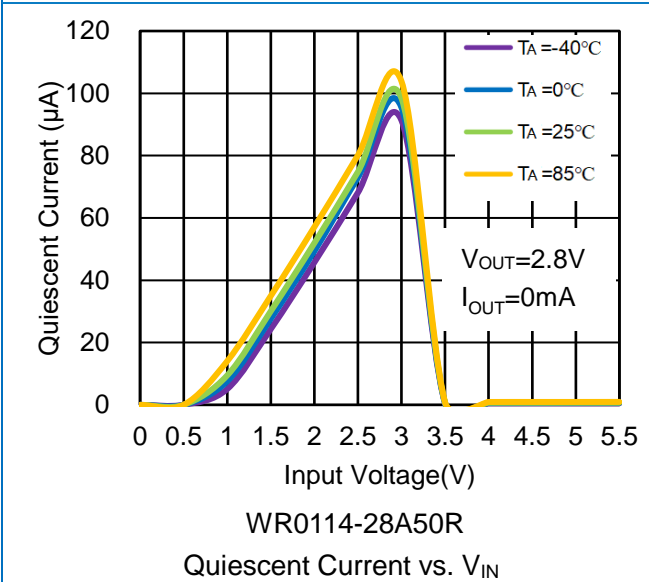
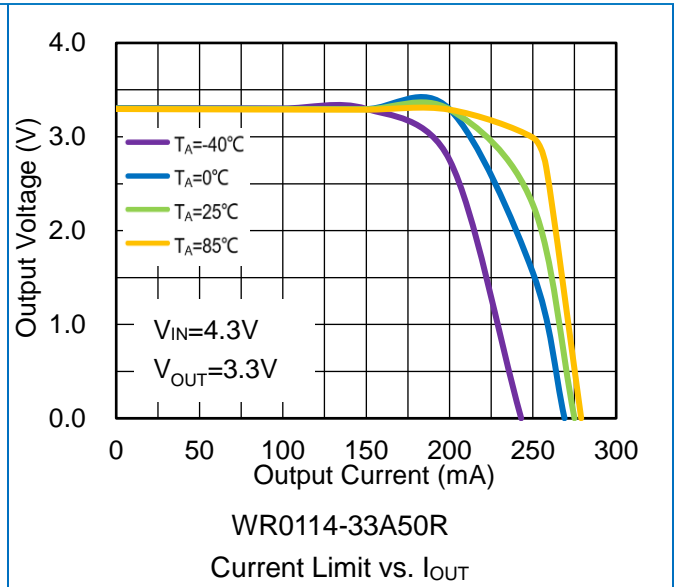
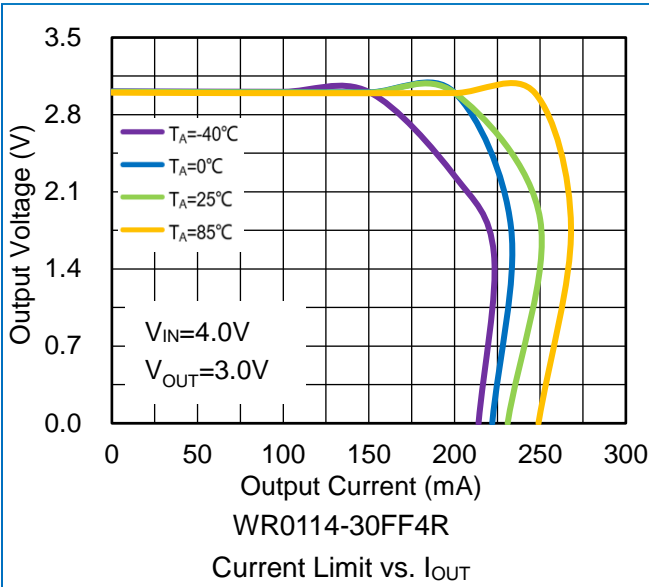

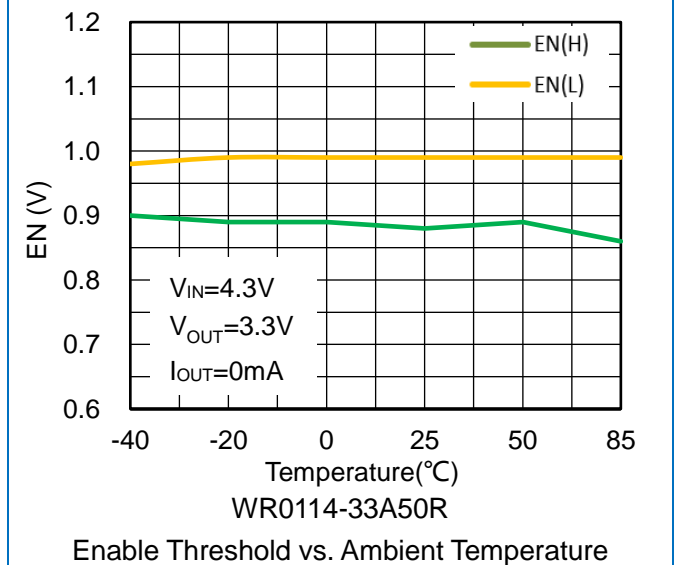
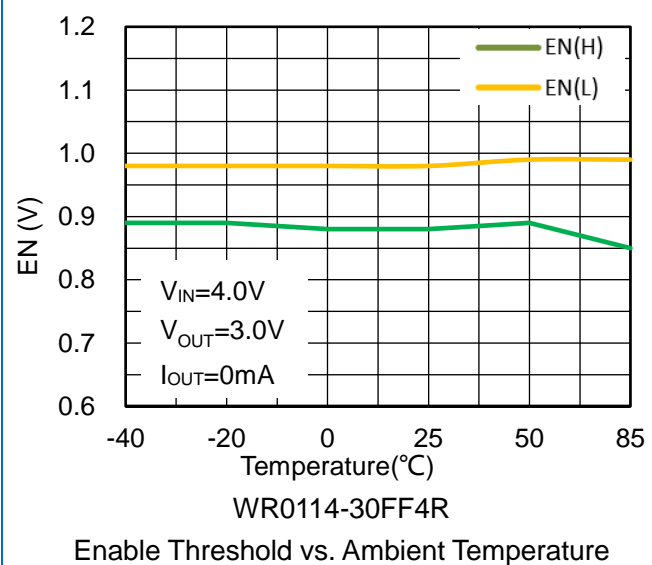
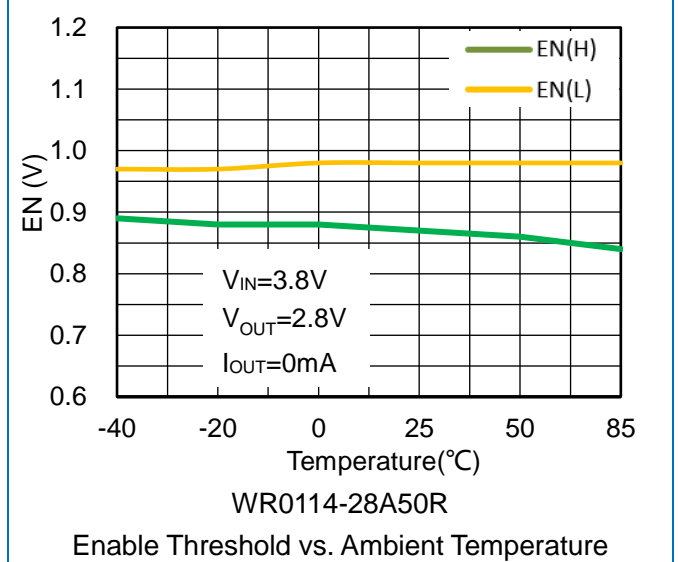
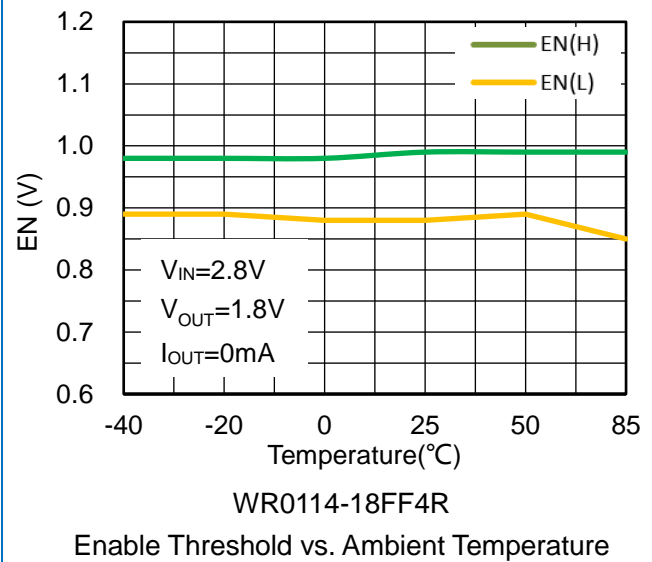
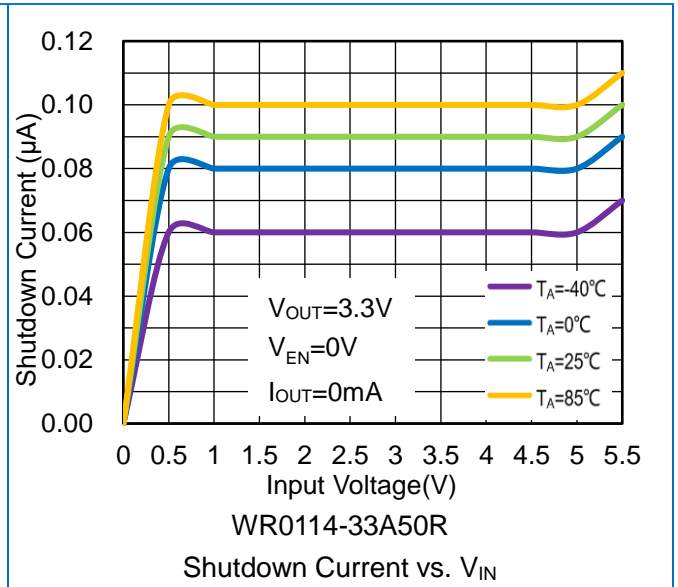
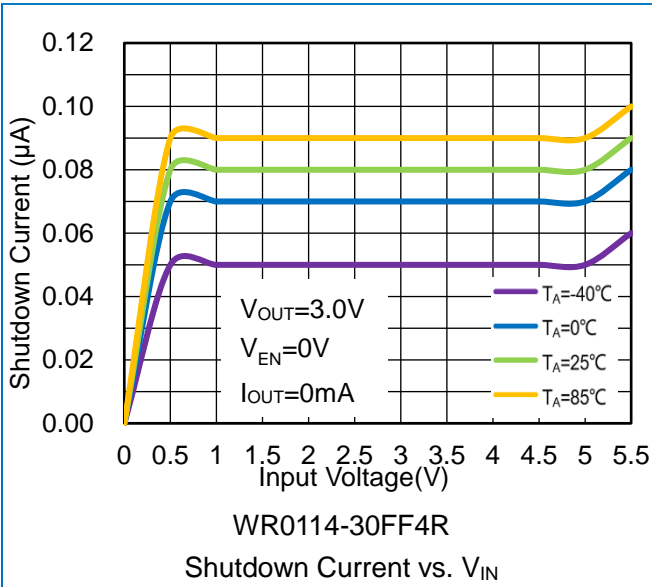

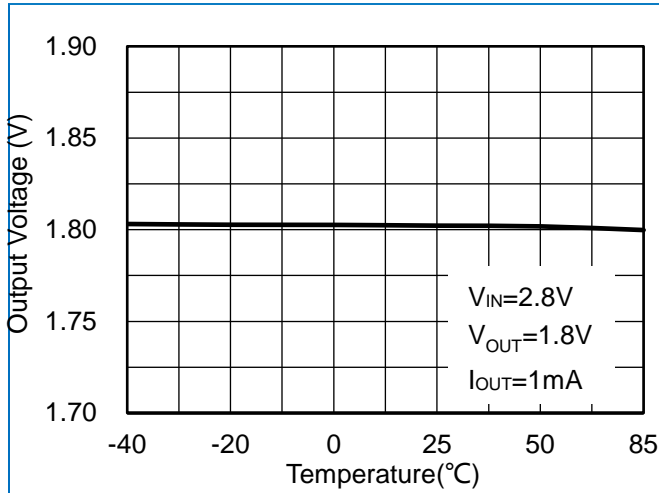

WR0114-18FF4R

Output Voltage vs. Ambient Temperature

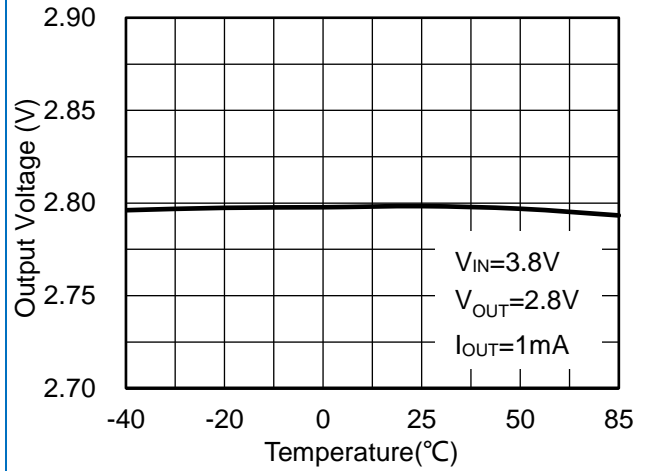

WR0114-28A50R

Output Voltage vs. Ambient Temperature

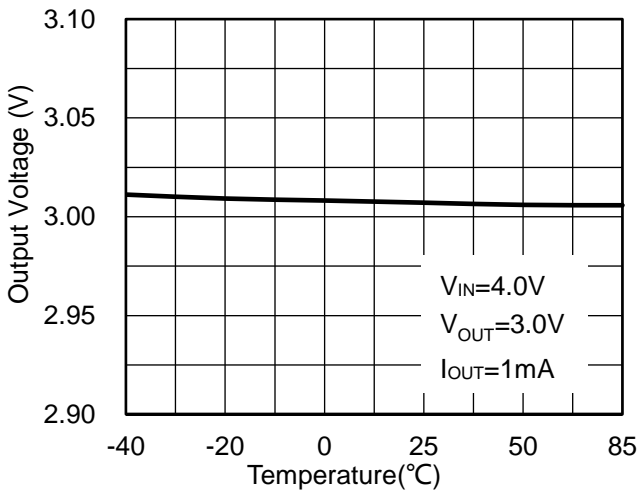

WR0114-30FF4R

Output Voltage vs. Ambient Temperature

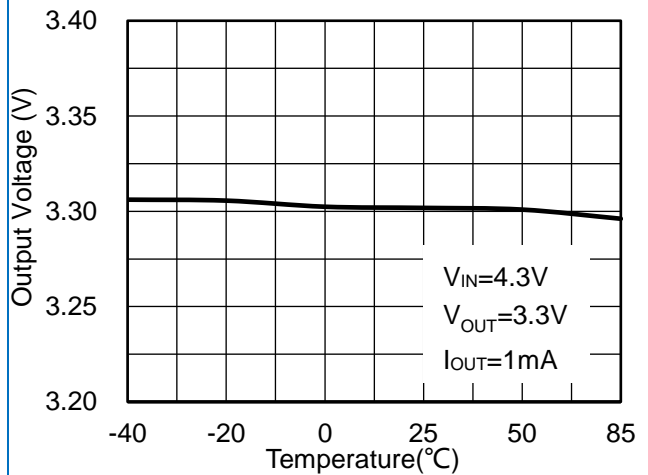

WR0114-33A50R

Output Voltage vs. Ambient Temperature

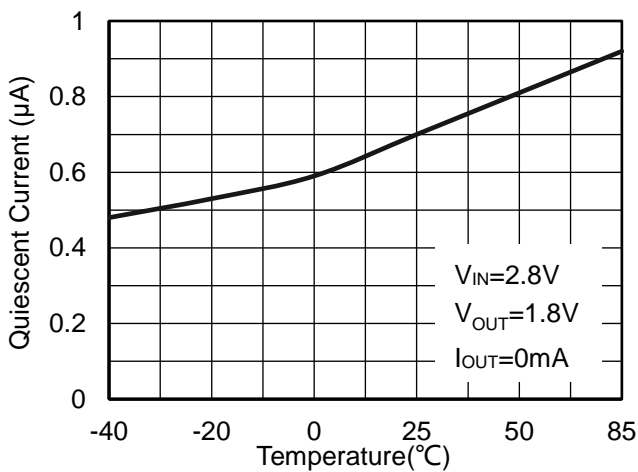

WR0114-18FF4R

Quiescent Current vs. Ambient Temperature

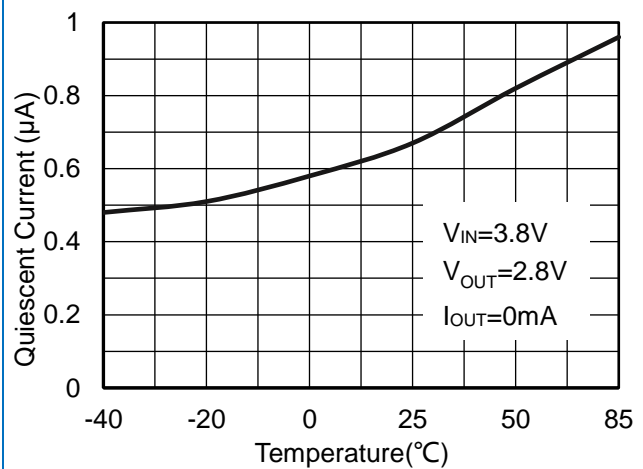

WR0114-28A50R

Quiescent Current vs. Ambient Temperature

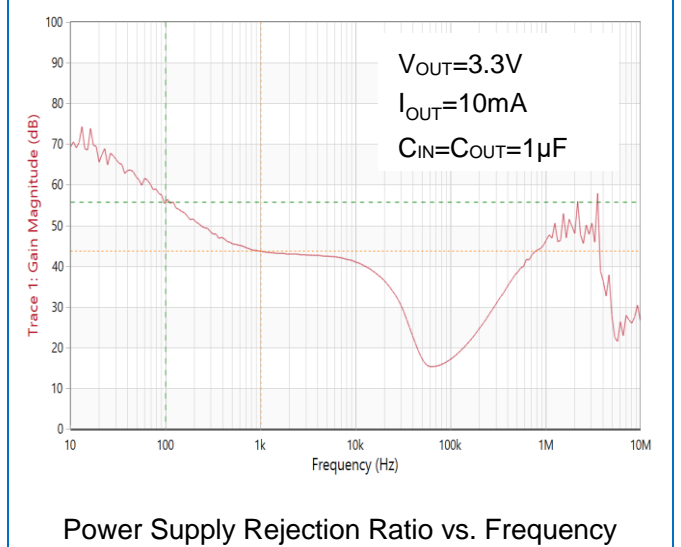
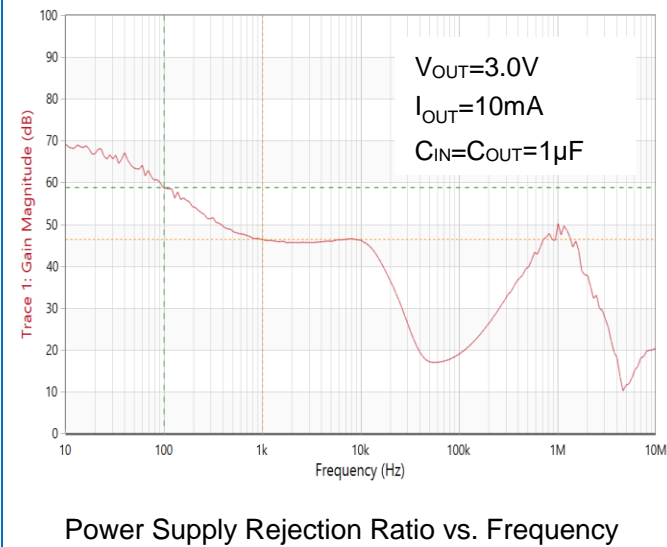
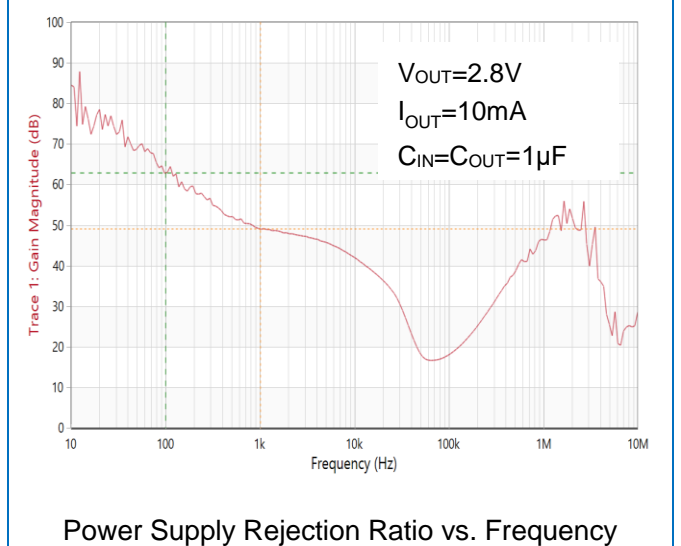
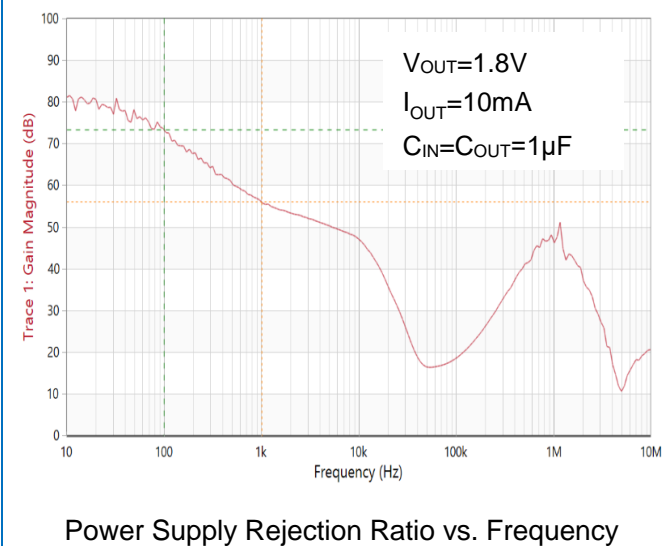
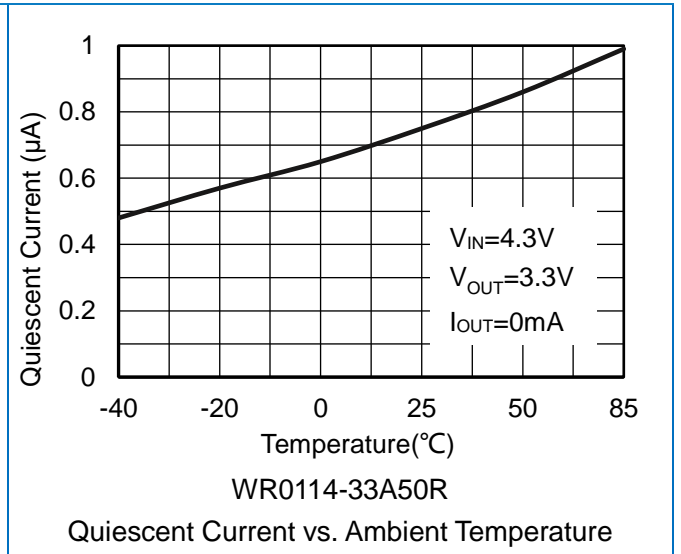
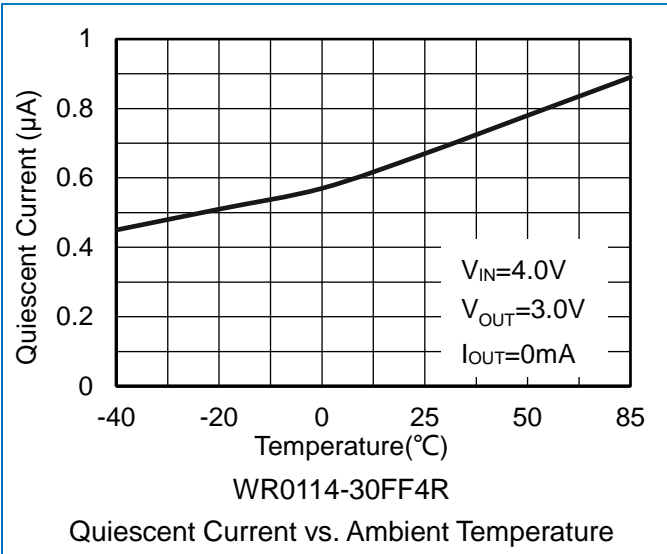

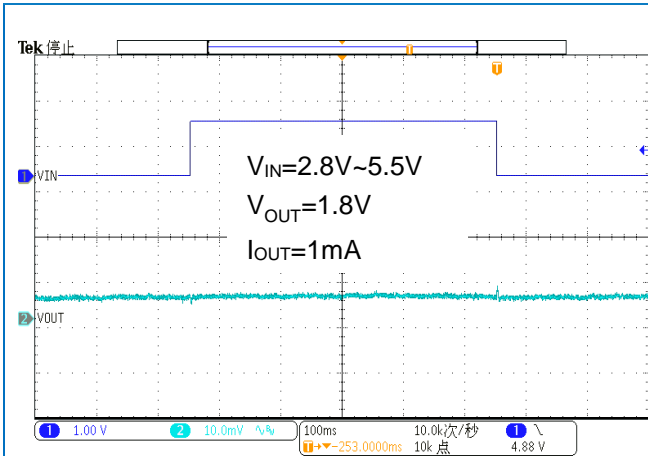

Line Transient

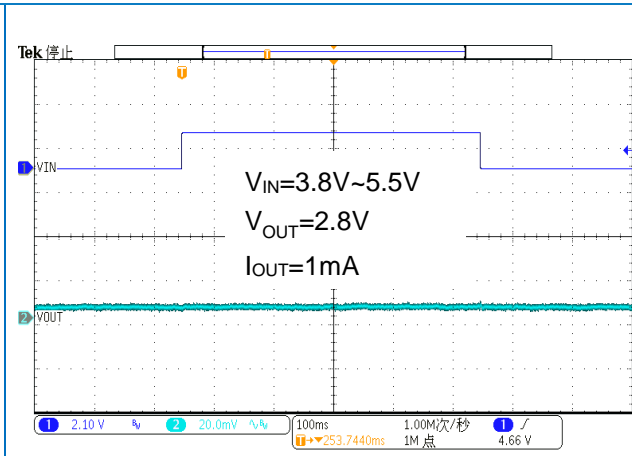

Line Transient

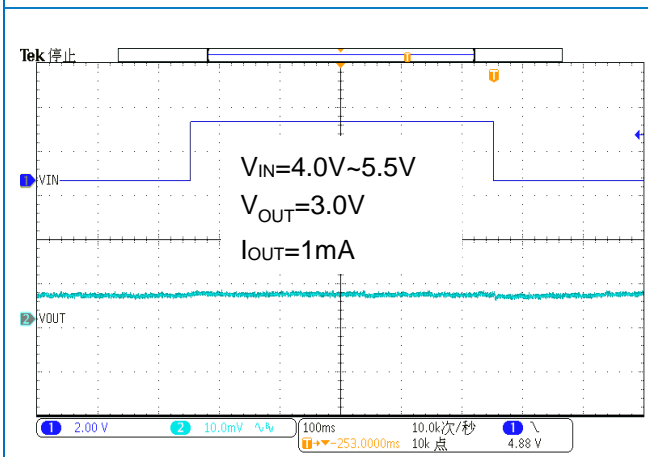

Line Transient

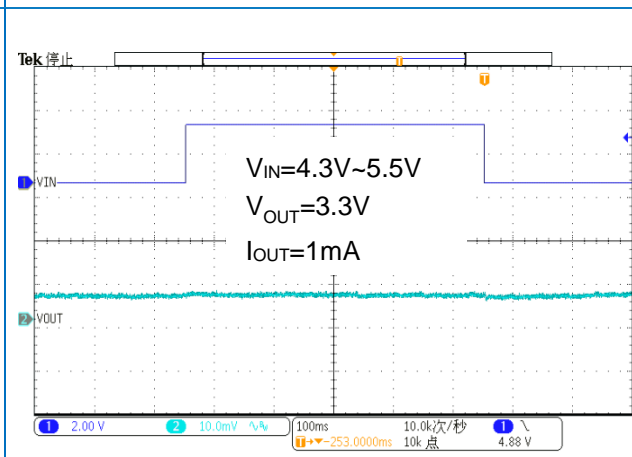

Line Transient

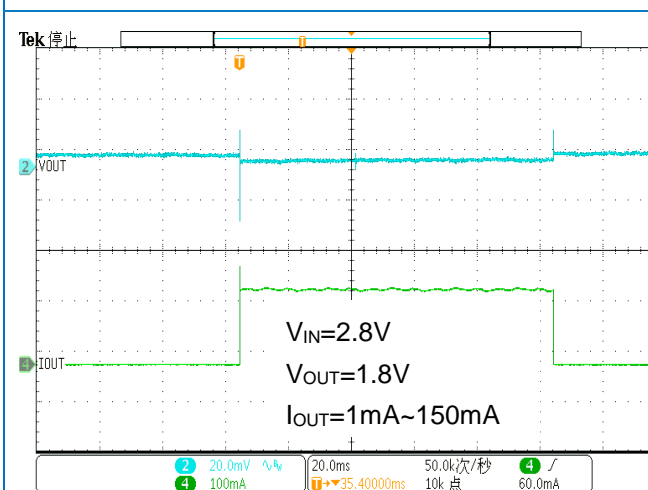

Load Transient

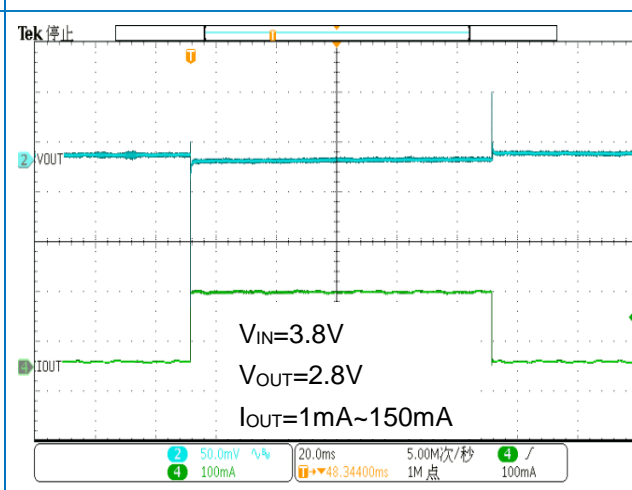

Load Transient

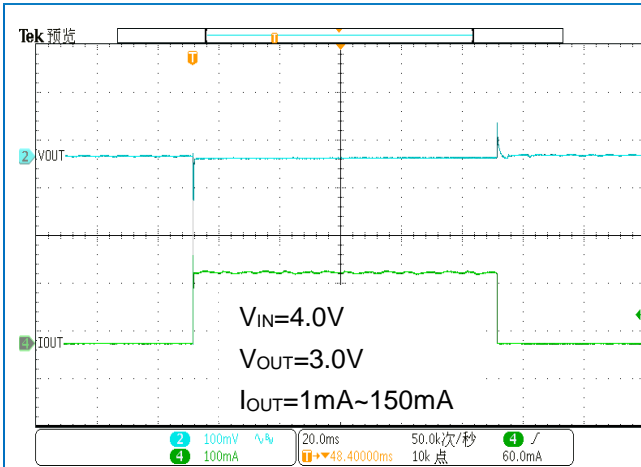

Load Transient

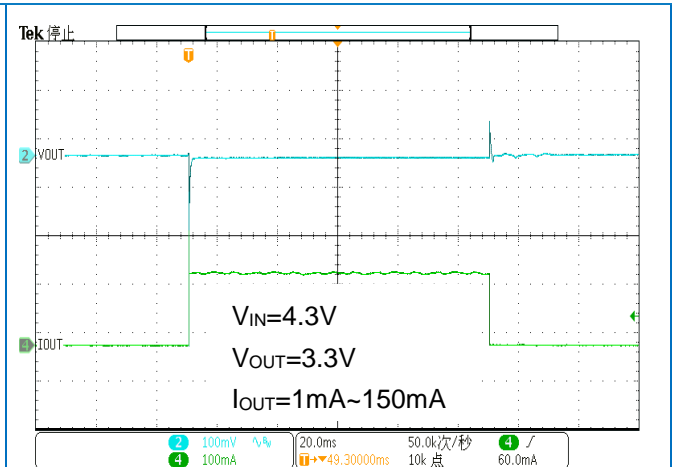

Load Transient

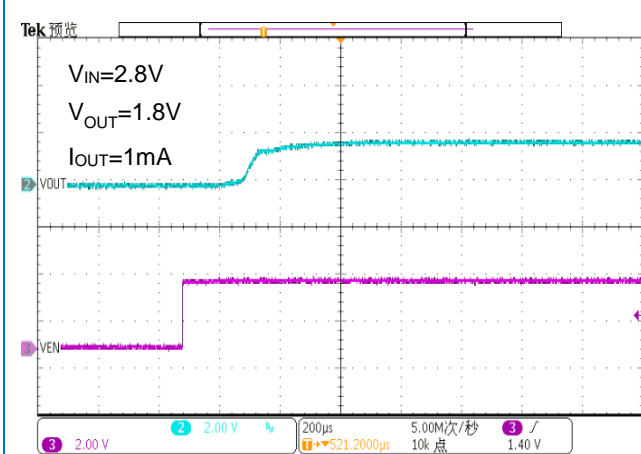

Soft Start from EN

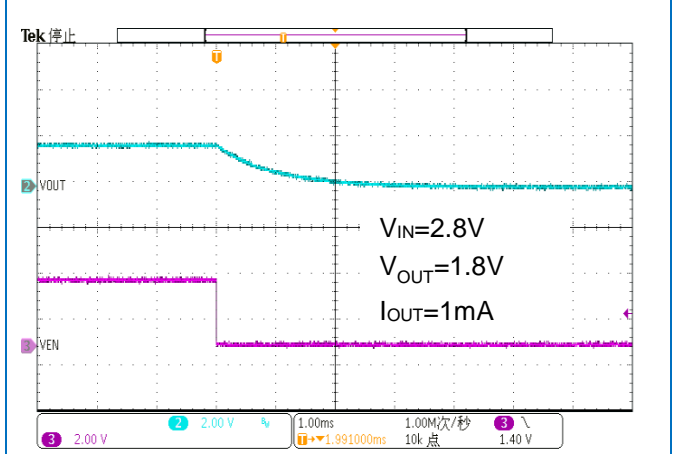

EN Shutdown

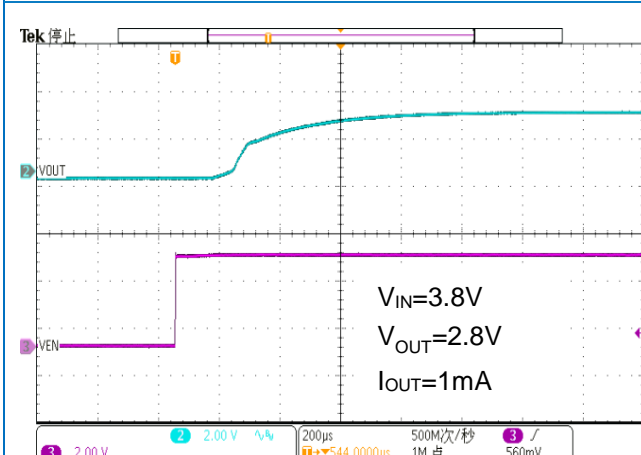

Soft Start from EN

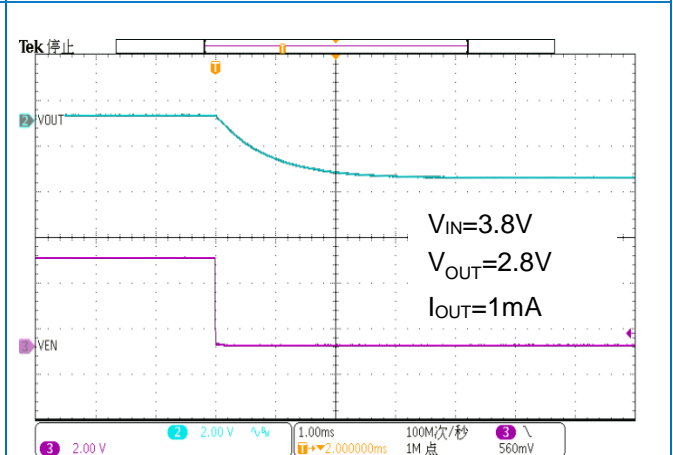

EN Shutdown

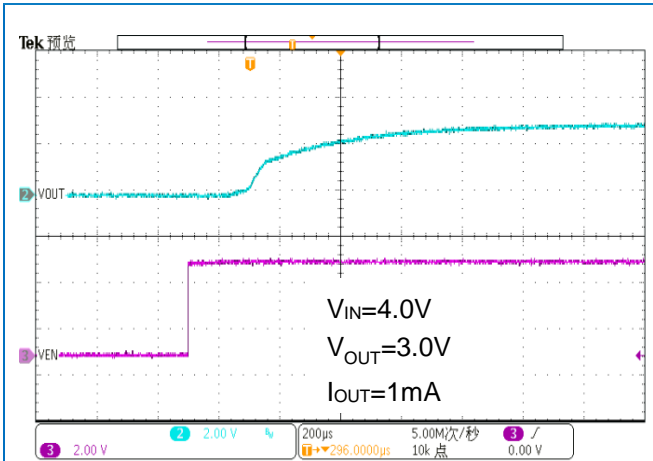

Soft Start from EN

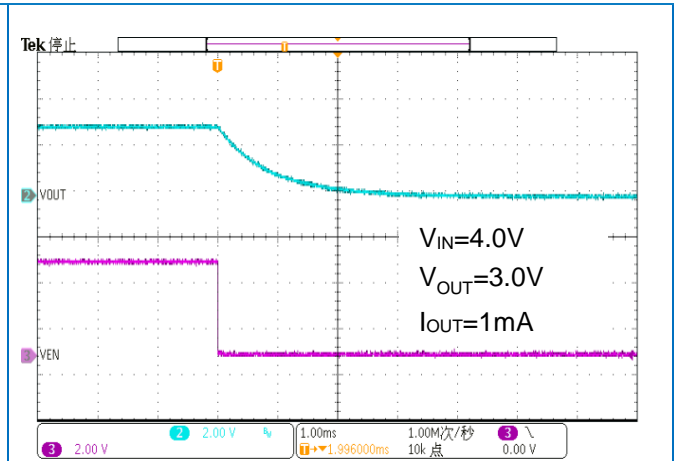

EN Shutdown

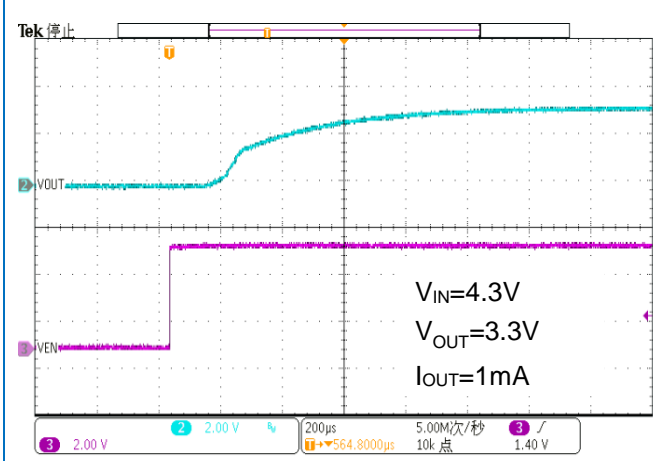

Soft Start from EN

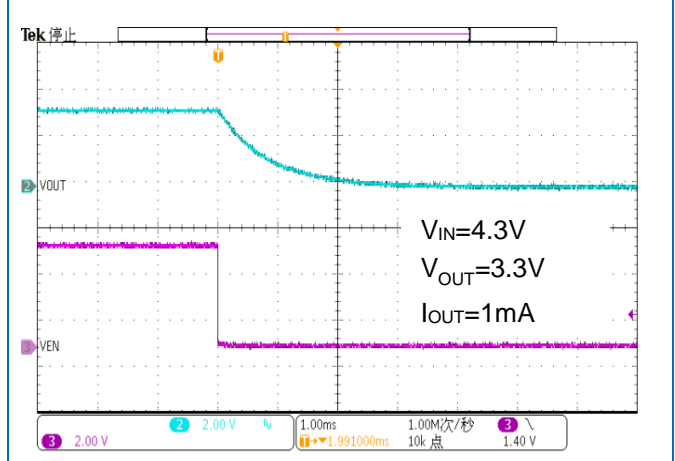

EN Shutdown

11. Function Description

11.1 Overview

The WR0114 series is a high efficiency regulator with high accuracy, low dropout voltage, 150mA output current and ultra-low power consumption. The input voltage range is 2.2V to 5.5V and the output voltage range is 1.2V to 3.3V, making the devices suitable for use in a variety of battery-driven electronic wearable products.

11.2 Block Diagram

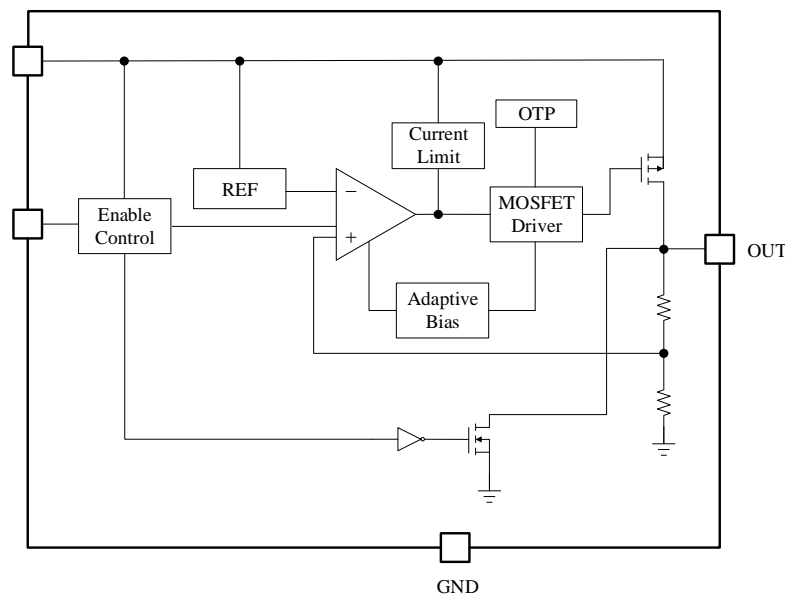

11.3 Feature Description

11.3.1 Output Voltage Accuracy

The WR0114 has an output voltage accuracy of 1%. Output voltage accuracy is defined as the maximum and minimum error in output voltage. This includes the errors introduced by internal reference, load regulation and line regulation differences over the full range of rated load and line operating conditions, taking into account differences between manufacturing lots.

11.3.2 Enable(EN)

The WR0114 enable pin contains a small pull-up current source, typically 0.1 μ A. When the input voltage of the enable pin is higher than the high enable voltage threshold, the device outputs normally. When the input voltage of the enable pin is lower than the low input voltage threshold of the EN pin, the device outputs shutdown. If you do not need to control the output voltage independently, connect the enable pin to the input of the device.

11.3.3 Drop Voltage (V_{DO})

WR0114 is a low dropout voltage LDO that can achieve nominal output voltage at lower input voltage. Dropout voltage is defined as the $V_{IN}-V_{OUT}$ at the rated maximum output current. When the input voltage is below the nominal output voltage, the output voltage varies with the input voltage.

11.3.4 Power Supply Rejection Ratio(PSRR)

PSRR, which stands for Power Supply Rejection Ratio, represents the ratio of the two voltage gains obtained when the input and output power supplies are considered as two independent sources.

The basic calculation formula is

$$\text{PSRR} = 20\log(\text{Ripple(in)} / \text{Ripple(out)})$$

The units are in decibels (dB) and the logarithmic ratio is used.

The above equation shows that the output signal is influenced by the power supply in general, in addition to the circuit itself. PSRR is a quantity used to describe how the output signal is affected by the power supply; the larger the PSRR, the less the output signal is affected by the power supply.

As the level of integration continues to increase, the magnitude of supply current required is also increasing. End users want to extend battery life, i.e. they need very efficient DC/DC conversion processes, using more efficient switching regulators. However, switching regulators generate more ripple in the power line than linear regulators.

The PSRR shows the ability of the LDO to suppress input voltage noise. For a clean, noise-free DC output voltage, use an LDO with a high PSRR.

Noise coupling from the input voltage to the internal reference voltage is the main cause of PSRR performance degradation. Using noise reduction capacitors at the input can effectively filter out noise and improve PSRR performance at low frequencies. The LDO can be used not only to regulate the voltage but also to provide an exceptionally clean DC supply for noise sensitive components.

11.3.5 Thermal Protection

The WR0114 contains a thermal shutdown protection circuit that implements the required switching gate circuit function through a thermal switch integrated inside the chip. The output current is turned off when the heat in the LDO is too high. Thermal shutdown occurs when the thermal junction temperature (T_J) of the energized crystal exceeds 175°C (typical). The thermal shutdown hysteresis ensures that the LDO resets (turns on) again when the temperature drops to 155°C (typical). The thermal time constant of the semiconductor chip is quite short, so when thermal shutdown is reached, the output turns on and off at a higher rate until the power dissipation is reduced.

The WR0114's internal protection circuitry is designed to prevent thermal overload conditions. This circuitry is not a substitute for a proper heat sink. Continuously putting the WR0114 into a thermal shutdown state will reduce the reliability of the device.

12. Application and Implementation

NOTE:The information in the Applications section below is not part of WAY-ON's product specifications and WAY-ON does not guarantee its accuracy or completeness. The customer is responsible for determining the suitability of the component for its intended use and should verify and test its design implementation to confirm system functionality.

12.1 Application Information

The WR0114 is a linear voltage regulator with an input voltage of 2.2 V to 5.5 V and an output voltage of 1.2 V to 3.3 V. The accuracy is 1% for output voltages up to 1.2 V to 3.3V. The maximum output current is 150mA. The efficiency of a linear voltage regulator is determined by the ratio of the output voltage to the input voltage, so in order to achieve high efficiency, the differential voltage ($V_{IN} - V_{OUT}$) must be as small as possible. This section discusses how best to use this device in practical applications.

12.1.1 Capacitor Recommendation

The WR0114 uses ceramic capacitors with low equivalent series resistance (ESR) at the V_{IN} and V_{OUT} pins to increase its stability. Multilayer ceramic capacitors are recommended. These capacitors also have limitations, and ceramic capacitors with X7R-, X5R-, and COG-rated dielectric materials have relatively good capacitance stability at different temperatures. WR0114 is designed to use ceramic capacitors of 1 μ F or larger at the input and output. Place C_{IN} and C_{OUT} as close to the IN and OUT pins as possible to minimize trace inductance from the capacitor to the device.

12.1.2 Power Dissipation(PD)

The reliability of the circuit requires reasonable consideration of the power dissipation of the device, the location of the circuit on the PCB, and the proper sizing of the thermal plane. No other heat generating devices as much as possible should surround the regulator. The power dissipation of the regulator depends on the input and output voltage difference and the load conditions.

PD can be calculated using the following equation:

$$P_D = (V_{IN} - V_{OUT}) \times I_{OUT}$$

Using the proper input voltage minimizes the power dissipation, resulting in greater efficiency. To obtain the lowest power dissipation, use the minimum input voltage required for normal output voltage.

The maximum power dissipation determines the maximum allowable ambient temperature (T_A) of the device. Power dissipation and junction temperature are typically related to the junction-ambient Thermal resistance (θ_{JA}) and ambient air temperature (T_A) of the PCB and package and are calculated as follows

$$T_J = T_A + (\theta_{JA} \times P_D)$$

The thermal resistance (θ_{JA}) depends primarily on the thermal dispersion capability of the PCB design. The total copper area, copper weight, and the location of the plane all affect the thermal dispersion capability, and the PCB and copper laydown area can only be used as a relative measure of the package's thermal performance.

12.1.3 Power supply recommendation

The WR0114 has a V_{IN} range of between 2.2 V and 5.5 V and an input capacitance of 1 μ F. The input voltage should have some redundancy to ensure a stable output voltage when the load fluctuates. If the input supply is noisy, additional input capacitors can be used to improve the noise performance of the output.

12.2 Typical Application

This section discusses the application of the WR0114 in the circuit. The following figure shows the schematic of the application circuit.

Circuit schematic 1: V_{OUT} normally open, no control.

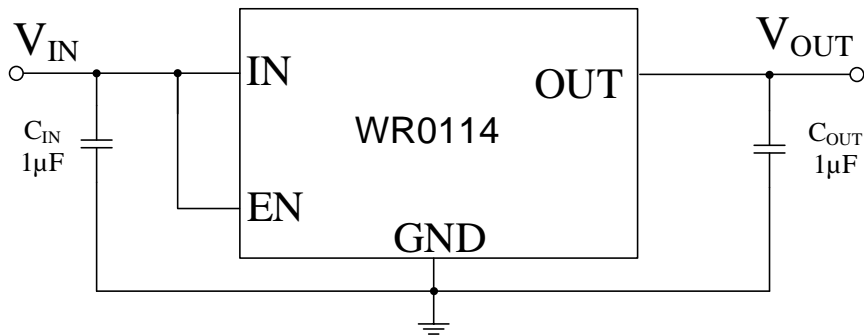

Circuit schematic 2: V_{OUT} control by external voltage to EN

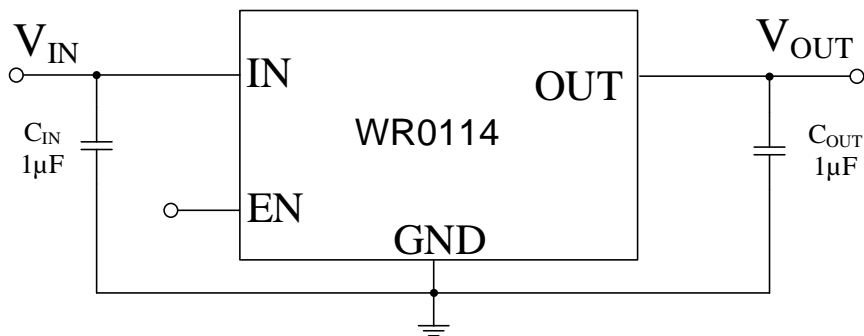

C_{IN} and C_{OUT} are to be selected with the recommended appropriate capacitance. $1\mu\text{F}$ ceramic capacitors are selected for both C_{IN} and C_{OUT} to help balance the charge needed to charge the output capacitor during startup, thus reducing the input voltage drop.

13. Layout Guidelines

The principle of LDO design is to place all components on the same side of the board and connect them as close as possible to their respective LDO pins. Connect the C_{IN} and C_{OUT} grounds, with all LDO ground pins as close together as possible, through a wide copper surface. Using through-holes and long wires for connections is strongly discouraged and can seriously affect system performance.

To improve thermal performance, an array of thermal via is used to connect the thermal pad to the ground plane. A larger ground plane improves the thermal performance of the device and reduces the operating temperature of the device.

Layout Example:

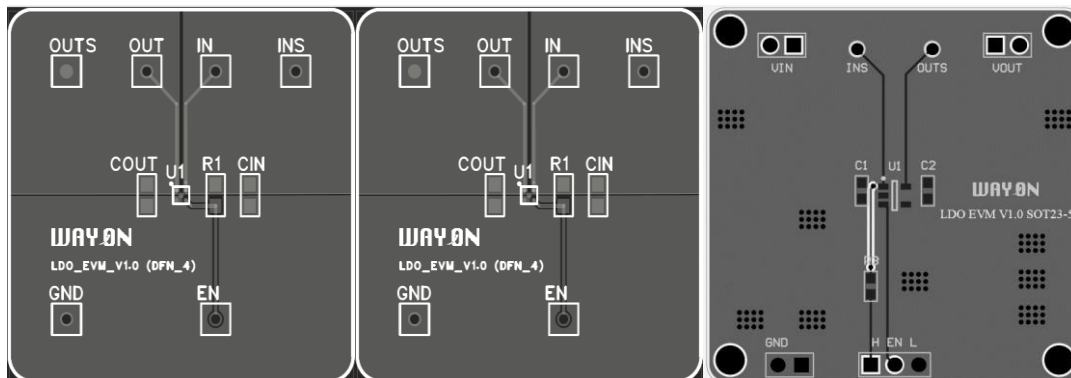

14. Evaluation Modules

XX Evaluation Modules (EVMs) are available to help evaluate initial circuit performance. We have evaluation modules for different packages, you can contact us by phone or address at the end to get the evaluation module or schematic.

The module names are listed in the table below.

NAME	PACKAGE	EVALUATION MODULE
WR0114	SOT23-3	WAYON LDO EVM V1.0 –SOT23-3
	SOT23-5	WAYON LDO EVM V1.0 –SOT23-5
	DFN-4	WAYON LDO EVM V1.0 –DFN-4

15. Naming Conventions

WR AA BB-CC DDD E

WR: WAYON Regulator;

AA: Output Current 150mA;

BB: Serial number;

CC: Output Voltage;

DDD: Package – A30: SOT23-3 / A50: SOT23-5 / FF4: DFN-4;

E: R-Reel & T-tube;

16. Electrostatic discharge warning

ESD can cause irreversible damage to integrated circuits, ranging from minor performance degradation to device failure. Precision ICs are more susceptible to damage because very minor parameter changes can cause the device to be out of compliance with its published specifications. WA-ON recommends that all ICs be handled with proper precautions. Failure to follow proper handling practices and installation procedures may damage the IC.

17. Package Information

SOT 23-3

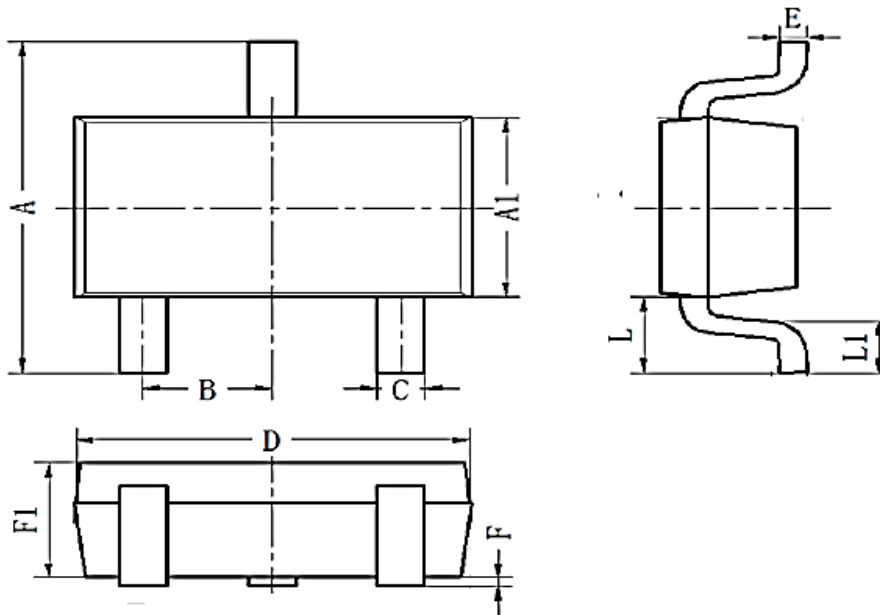

SYMBOL	DIMENSIONS IN MILLIMETERS		
	MIN	NOM	MAX
A	2.60	2.80	3.00
A1	1.50	1.60	1.70
B	0.95BSC		
C	0.25	0.40	0.50
D	2.82	2.92	3.02
E	0.10	0.15	0.20
L	0.59REF		
L1	0.30	0.45	0.60
F1	0.90	1.10	1.30
F	0.00	0.08	0.15

SOT 23-5

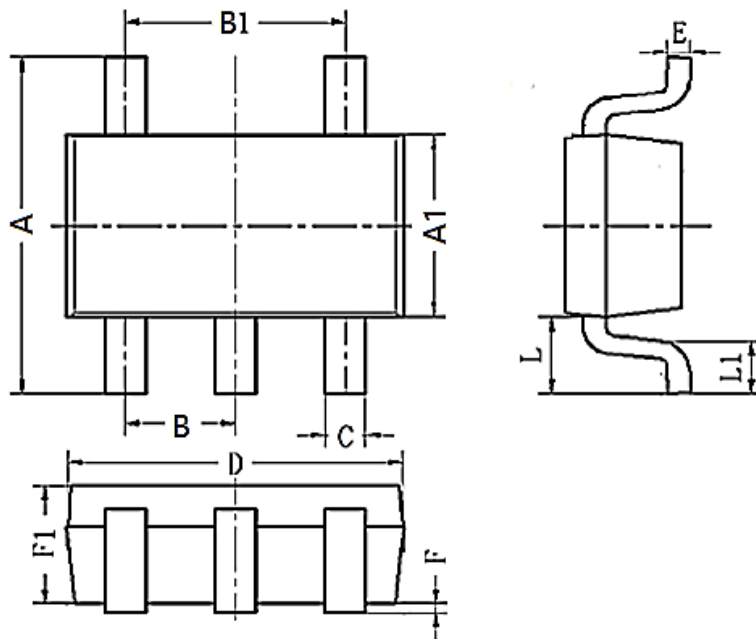

SYMBOL	DIMENSIONS IN MILLIMETERS		
	MIN	NOM	MAX
A	2.60	2.80	3.00
A1	1.50	1.60	1.70
B	0.95BSC		
B1	1.90BSC		
C	0.25	0.40	0.50
D	2.82	2.92	3.02
E	0.10		
F	0.00	0.08	0.15
L	0.59REF		
F1	0.90	1.10	1.30

DFN-4

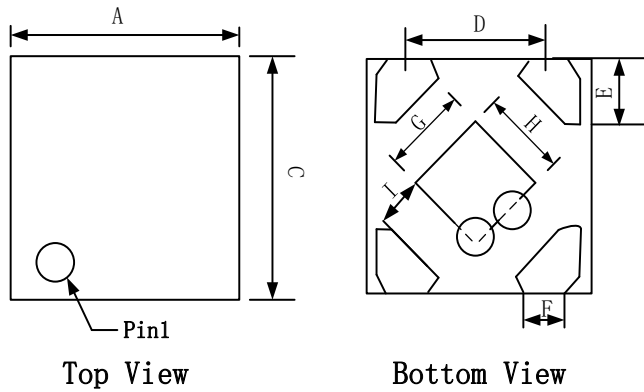

DETAIL A

Pin 1 ID and Tie Bar Mark Options

NOTE: The configuration of the Pin 1 identifier is optional, but must be

SYMBOL	DIMENSIONS IN MILLIMETERS		
	MIN	NOM	MAX
A	0.950	1.000	1.050
B	0.320	0.370	0.420
C	0.950	1.000	1.050
D	0.650BCS		
E	0.170	0.270	0.370
F	0.130	0.235	0.300
G	0.430	0.485	0.540
H	0.430	0.485	0.540
I	0.200REF		

18. Ordering Information

PART NUMBER	OUTPUT VOLTAGE	PACKAGE	PACKING QUANTITY	MARKING*
WR0114-12A30R	1.2V	SOT23-3	3k/Reel	WR0114 12 XXXX
WR0114-15A30R	1.5V	SOT23-3	3k/Reel	WR0114 15 XXXX
WR0114-18A30R	1.8V	SOT23-3	3k/Reel	WR0114 18 XXXX
WR0114-185A30R	1.85V	SOT23-3	3k/Reel	WR0114 185 XXXX
WR0114-21A30R	2.1V	SOT23-3	3k/Reel	WR0114 21 XXXX
WR0114-22A30R	2.2V	SOT23-3	3k/Reel	WR0114 22 XXXX
WR0114-25A30R	2.5V	SOT23-3	3k/Reel	WR0114 25 XXXX
WR0114-28A30R	2.8V	SOT23-3	3k/Reel	WR0114 28 XXXX
WR0114-30A30R	3.0V	SOT23-3	3k/Reel	WR0114 30 XXXX
WR0114-33A30R	3.3V	SOT23-3	3k/Reel	WR0114 33 XXXX
WR0114-12A50R	1.2V	SOT23-5	3k/Reel	WR0114 12 XXXX
WR0114-15A50R	1.5V	SOT23-5	3k/Reel	WR0114 15 XXXX
WR0114-18A50R	1.8V	SOT23-5	3k/Reel	WR0114 18 XXXX
WR0114-185A50R	1.85V	SOT23-5	3k/Reel	WR0114 185 XXXX
WR0114-21A50R	2.1V	SOT23-5	3k/Reel	WR0114 21 XXXX
WR0114-22A50R	2.2V	SOT23-5	3k/Reel	WR0114 22 XXXX
WR0114-25A50R	2.5V	SOT23-5	3k/Reel	WR0114 25 XXXX
WR0114-28A50R	2.8V	SOT23-5	3k/Reel	WR0114 28 XXXX
WR0114-30A50R	3.0V	SOT23-5	3k/Reel	WR0114 30 XXXX
WR0114-33A50R	3.3V	SOT23-5	3k/Reel	WR0114 33 XXXX

PART NUMBER	OUTPUT VOLTAGE	PACKAGE	PACKING QUANTITY	MARKING*
WR0114-12FF4R	1.2V	DFN1x1-4	10k/Reel	114 12
WR0114-15FF4R	1.5V	DFN1x1-4	10k/Reel	114 15
WR0114-18FF4R	1.8V	DFN1x1-4	10k/Reel	114 18
WR0114-185FF4R	1.85V	DFN1x1-4	10k/Reel	114 185
WR0114-21FF4R	2.1V	DFN1x1-4	10k/Reel	114 21
WR0114-22FF4R	2.2V	DFN1x1-4	10k/Reel	114 22
WR0114-25FF4R	2.5V	DFN1x1-4	10k/Reel	114 25
WR0114-28FF4R	2.8V	DFN1x1-4	10k/Reel	114 28
WR0114-30FF4R	3.0V	DFN1x1-4	10k/Reel	114 30
WR0114-33FF4R	3.3V	DFN1x1-4	10k/Reel	114 33

* XXXX is variable.

Contact Information

No.1001, Shiwan(7) Road, Pudong District, Shanghai, P.R.China.201207

Tel: 86-21-50310888 Fax: 86-21-50757680 Email: market@way-on.com

WAYON website: <http://www.way-on.com>

For additional information, please contact your local Sales Representative.

WAYON® is registered trademark of Wayon Corporation.

Specifications are subject to change without notice.

The device characteristics and parameters in this data sheet can and do vary in different applications and actual device performance may vary over time.

Users should verify actual device performance in their specific applications.

Product Specification Statement

- The product specification aims to provide users with a reference regarding various product parameters, performance, and usage. It presents certain aspects of the product's performance in graphical form and is intended solely for users to select product and make product comparisons, enabling users to better understand and evaluate the characteristics and advantages of the product. It does not constitute any commitment, warranty, or guarantee.
- The product parameters described in the product specification are numerical values, characteristics, and functions obtained through actual testing or theoretical calculations of the product in an independent or ideal state. Due to the complexity of product applications and variations in test conditions and equipment, there may be slight fluctuations in parameter test values. WAYON shall not guarantee that the actual performance of the product when installed in the customer's system or equipment will be entirely consistent with the product specification, especially concerning dynamic parameters. It is recommended that users consult with professionals for product selection and system design. Users should also thoroughly validate and assess whether the actual parameters and performance when installed in their respective systems or equipment meet their requirements or expectations. Additionally, users should exercise caution in verifying product compatibility issues, and WAYON assumes no responsibility for the application of the product.
- WAYON strives to provide accurate and up-to-date information to the best of our ability. However, due to technical, human, or other reasons, WAYON cannot guarantee that the information provided in the product specification is entirely accurate and error-free. WAYON shall not be held responsible for any losses or damages resulting from the use or reliance on any information in these product specifications. WAYON reserves the right to revise or update the product specification and the products at any time without prior notice, and the user's continued use of the product specification is considered an acceptance of these revisions and updates. Prior to purchasing and using the product, users should verify the above information with WAYON to ensure that the product specification is the most current, effective, and complete. If users are particularly concerned about product parameters, please consult WAYON in detail or request relevant product test reports. Any data not explicitly mentioned in the product specification shall be subject to separate agreement.
- Users are advised to pay attention to the parameter limit values specified in the product specification and maintain a certain margin in design or application to ensure that the product does not exceed the parameter limit values defined in the product specification. This precaution should be taken to avoid exceeding one or more of the limit values, which may result in permanent irreversible damage to the product, ultimately affecting the quality and reliability of the system or equipment.
- The design of the product is intended to meet civilian needs and is not guaranteed for use in harsh environments or precision equipment. It is not recommended for use in systems or equipment such as medical devices, aircraft, nuclear power, and similar systems, where failures in these systems or equipment could reasonably be expected to result in personal injury. WAYON shall assume no responsibility for any consequences resulting from such usage.
- Users should also comply with relevant laws, regulations, policies, and standards when using the product specification. Users are responsible for the risks and liabilities arising from the use of the product specification and must ensure that it is not used for illegal purposes. Additionally, users should respect the intellectual property rights related to the product specification and refrain from infringing upon any third-party legal rights. WAYON shall assume no responsibility for any disputes or controversies arising from the above-mentioned issues in any form.