

## 500V 5A 1.35Ω N-ch Power MOSFET

### Description

WMOS D1 is Wayon's 1<sup>st</sup> generation VDMOS family that is dramatic reduction in on-resistance and ultra-low gate charge for applications requiring high power density and high efficiency. And it is very robust and RoHS compliant.

### Features

- Typ. $R_{DS(on)}=1.35\Omega@V_{GS}=10V$
- 100% avalanche tested
- RoHS Compliant

### Applications

- SMPS
- Charger
- DC-DC

TO-252

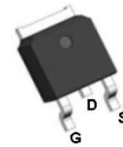

TO-220F

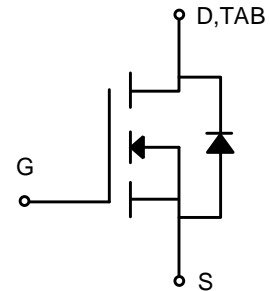

### Absolute Maximum Ratings ( $T_c=25^\circ\text{C}$ )

Parameter	Symbol	WMO5N50D1B	WML5N50D1B	Unit
Drain-source voltage	$V_{DSS}$	500		V
Gate-source voltage	$V_{GS}$	$\pm 30$		V
Continuous drain current	$I_D$	5		A
Pulsed drain current <sup>1</sup>	$I_{DM}$	20		A
Avalanche energy, single pulse <sup>2</sup>	$E_{AS}$	245		mJ
Power dissipation	$P_D$	45	38.5	W
Derate above 25°C		0.36	0.3	W/°C
Operating junction temperature	$T_j$	-55~150		°C
Storage temperature	$T_{stg}$	-55~150		°C
Continuous diode forward current	$I_S$	5		A
Diode pulse current <sup>1</sup>	$I_{Spulse}$	20		A

### Thermal Characteristic

Thermal resistance, junction-to-case	$R_{\theta JC}$	2.8	3.25	°C/W
Thermal resistance, junction-to-ambient	$R_{\theta JA}$	62.5	62.5	°C/W

## Electrical Characteristics of MOSFET

				Min.	Typ.	Max.	
Drain-source break down voltage	$BV_{DSS}$	$I_D=250\mu A, V_{GS}=0V$	$T_C=25^\circ C$	500	-	-	V
Gate threshold voltage	$V_{GS(th)}$	$I_D=250\mu A, V_{DS}=V_{GS}$	$T_J=25^\circ C$	2.0	-	4.0	V
Drain-source leakage current	$I_{DSS}$	$V_{DS}=500V, V_{GS}=0V$	$T_J=25^\circ C$	-	-	1	$\mu A$
		$V_{DS}=400V, V_{GS}=0V$	$T_J=125^\circ C$	-	-	100	$\mu A$
Gate-source leakage current,forward	$I_{GSSF}$	$V_{DS}=0V, V_{GS}=30V$	$T_J=25^\circ C$	-	-	100	nA
Gate-source leakage current,reverse	$I_{GSSR}$	$V_{DS}=0V, V_{GS}=-30V$	$T_J=25^\circ C$	-	-	-100	nA
Drain-source on-state resistance <sup>3</sup>	$R_{DS(on)}$	$V_{GS}=10V, I_D=2.5A$	$T_J=25^\circ C$	-	1.35	1.6	$\Omega$

## Dynamic Characteristics of MOSFET ( $T_C=25^\circ C$ )

				Min.	Typ.	Max.	
Input capacitance	$C_{iss}$	$f=1MHz, V_{DS}=25V,$ $V_{GS}=0V$		-	597	-	pF
Output capacitance	$C_{oss}$			-	63	-	pF
Reverse transfer capacitance	$C_{rss}$			-	6	-	pF
Gate to source charge	$Q_{gs}$	$V_{DD}=250V$		-	7	-	nC
Gate to drain charge	$Q_{gd}$	$I_D=5A$		-	6	-	nC
Total gate charge	$Q_g$	$V_{GS}= 0 \text{ to } 10V$		-	23	-	nC

## Switching Characteristics of MOSFET ( $T_C=25^\circ C$ )

				Min.	Typ.	Max.	
Turn-on delay time	$t_{d on}$	$V_{DS}=250V, I_D=5A,$ $R_G=25\Omega, V_{GS}=0 \text{ to } 10V$		-	12	-	ns
Rise time	$t_r$			-	17	-	ns
Turn-off delay time	$t_{d off}$			-	40	-	ns
Fall time	$t_f$			-	19	-	ns

## Characteristics of Body Diode ( $T_C=25^\circ C$ )

				Min.	Typ.	Max.	
Forward voltage	$V_{SD}$	$I_{SD}=5A, V_{GS}=0V$		-	-	1.4	V
Reverse recovery time	$t_{rr}$	$V_{DS}=500V, I_S=5A, V_{GS}=0V$ $di/dt=100A/us$		-	226	-	ns
Reverse recovery current	$I_{rr}$			-	12	-	A
Recovery charge	$Q_{rr}$			-	1.4	-	$\mu C$

### Notes:

1. Repetitive rating, pulse width limited by junction temperature  $T_{J(MAX)}=150^\circ C$ .
2. The  $E_{AS}$  data shows Max. rating . The test condition is  $V_{DD}=50V, V_{GS}=10V, L=10mH, I_{AS}=7A, T_C=25^\circ C$ .
3. The data tested by pulsed , pulse width  $\leq 300us$  , duty cycle  $\leq 2\%$ .

**TYPICAL CHARACTERISTICS**

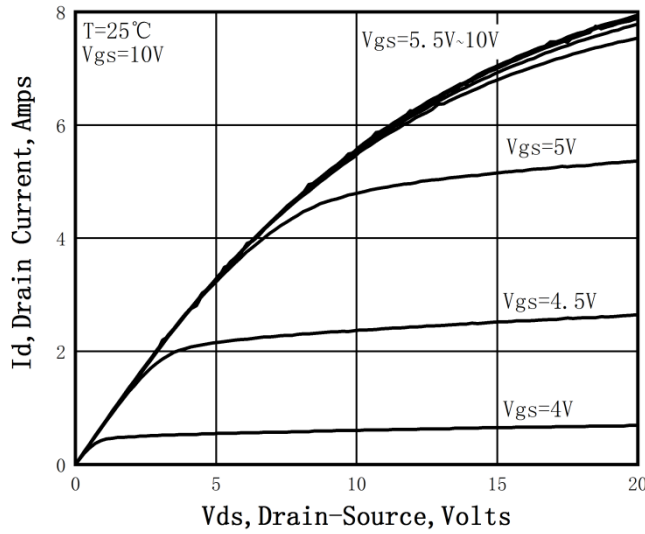

Figure 1. On-Region Characteristics

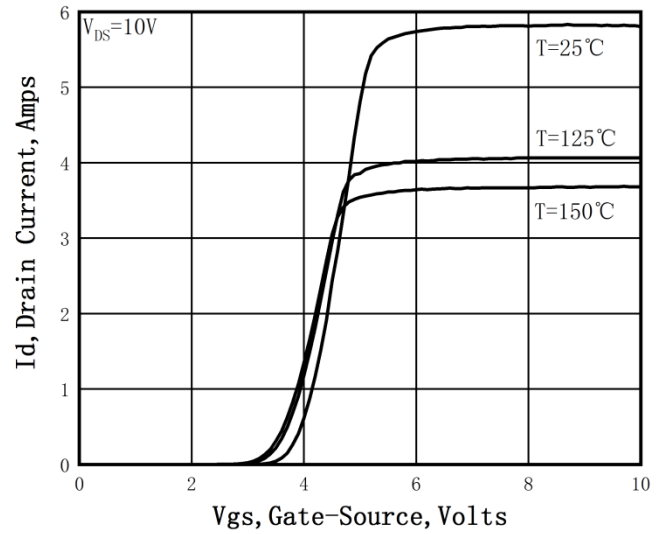

Figure 2. Transfer Characteristics

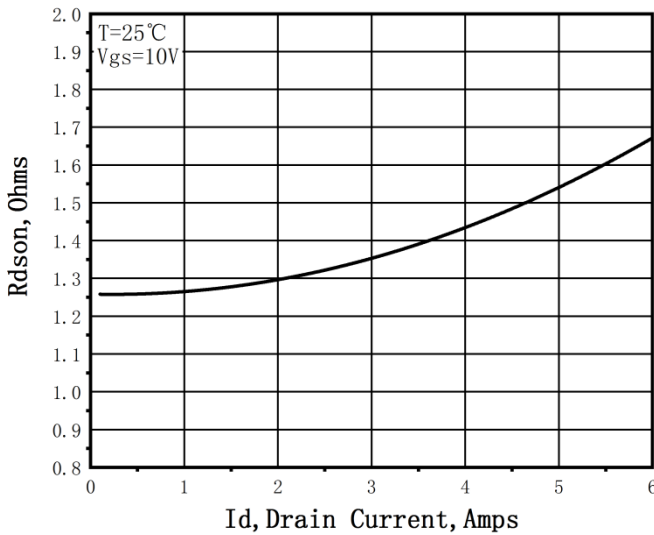

Figure 3. Static Drain-Source On Resistance

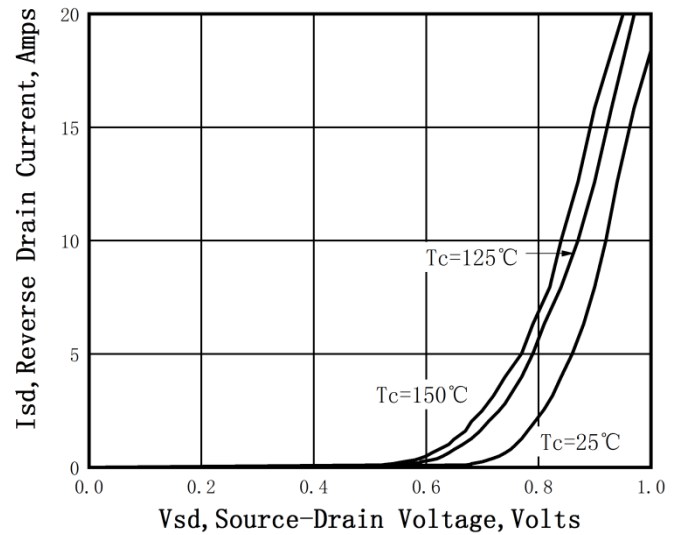

Figure 4. Typical Body Diode Transfer Characteristics

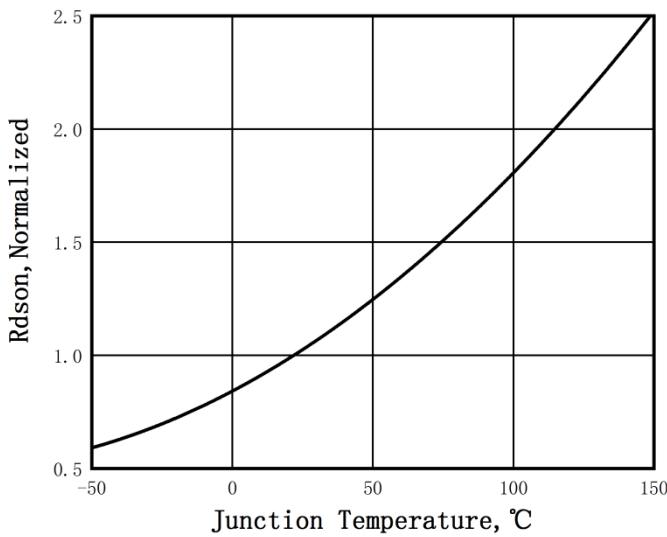

Figure 5. Normalized  $R_{DS(on)}$  vs. Temperature

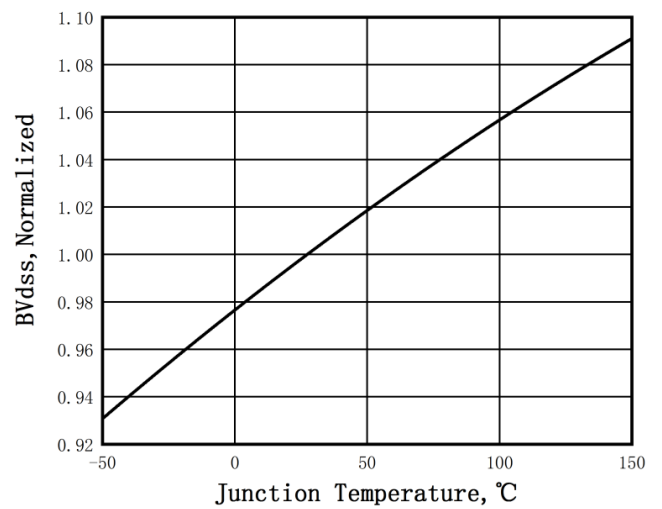

Figure 6. Normalized  $BV_{DSS}$  vs. Temperature

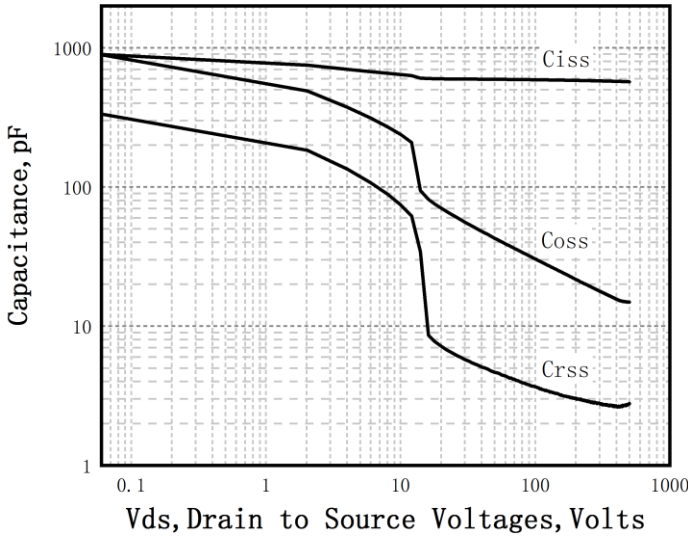

Figure 7. Capacitance Characteristics

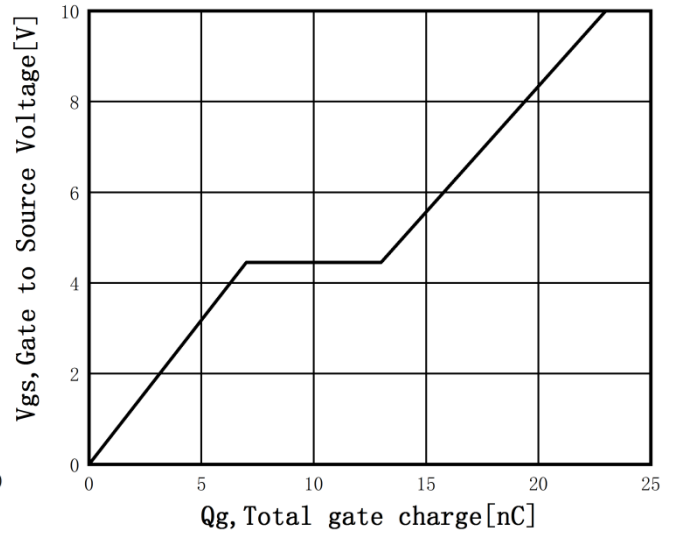

Figure 8. Gate Charge Characteristics

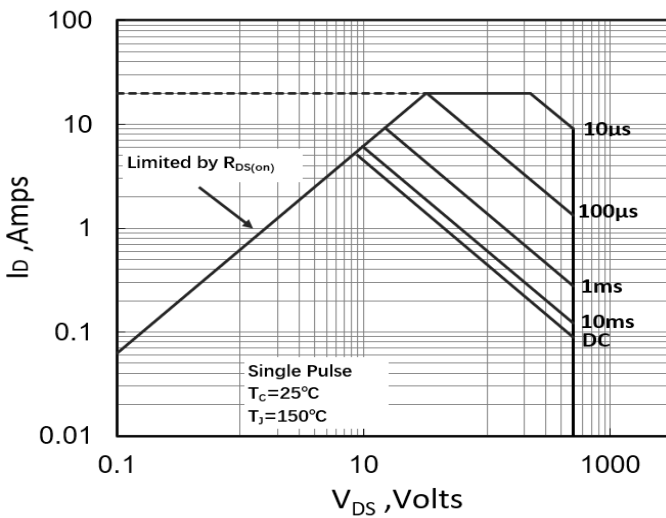

Figure 9. Maximum Safe Operating Area (TO-252)

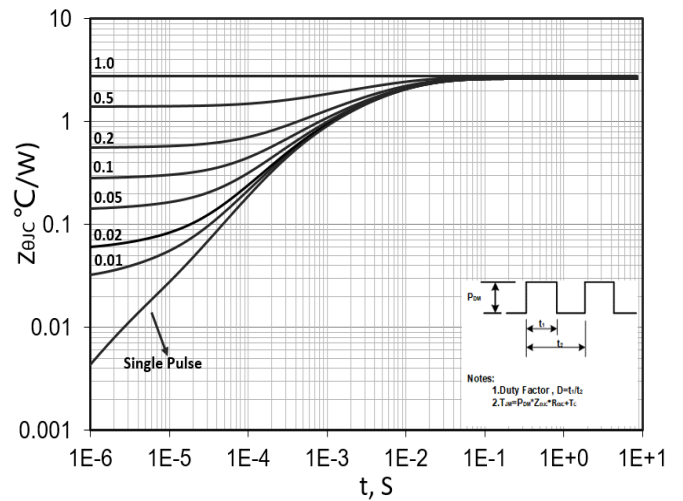

Figure 10. Transient Thermal Response Curve (TO-252)

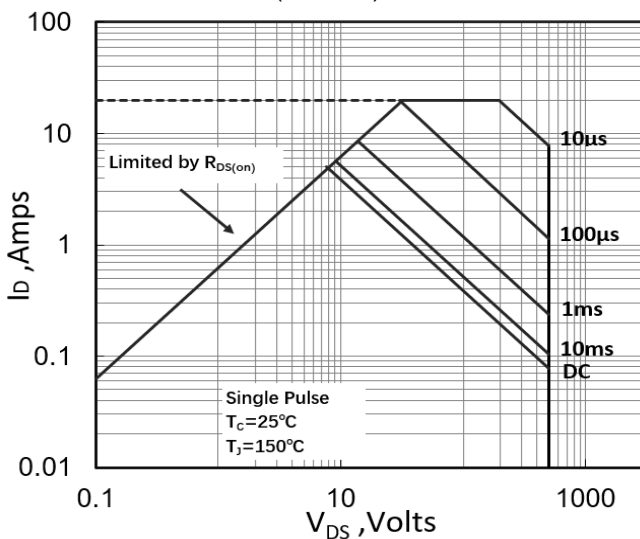

Figure 11. Maximum Safe Operating Area (TO-220F)

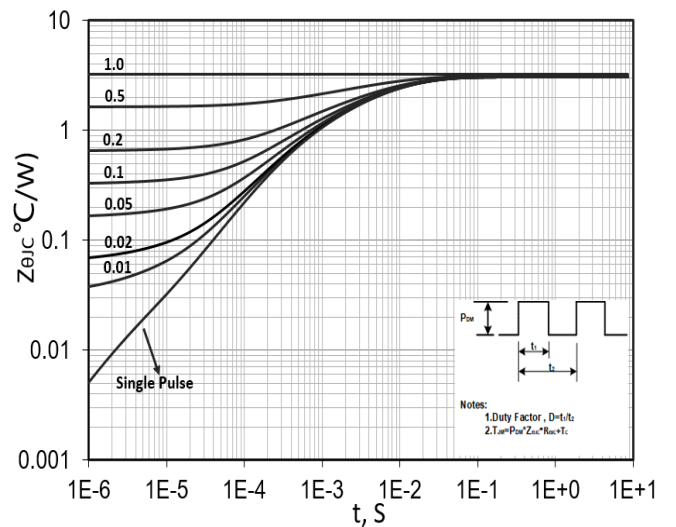
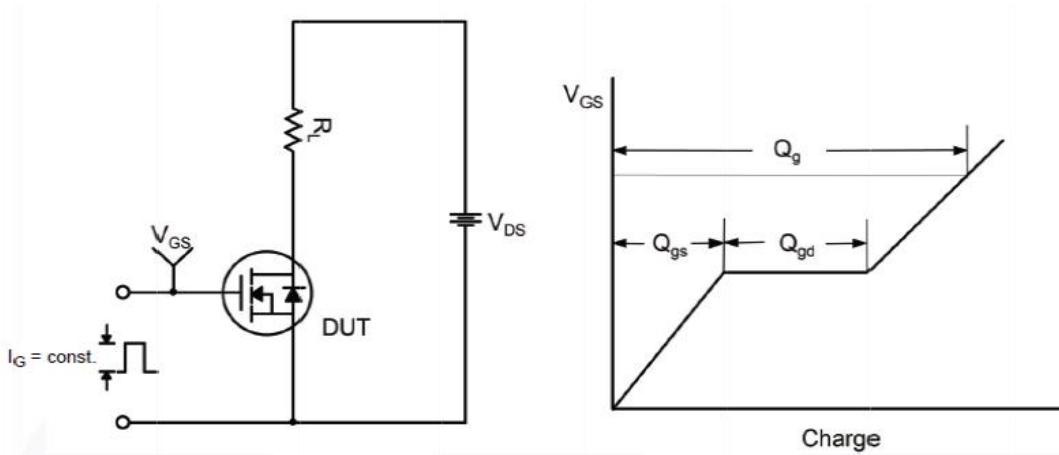

Figure 12. Transient Thermal Response Curve (TO-220F)

Test Circuit

Gate Charge Test Circuit & Waveform



Switching Test Circuit & Waveforms

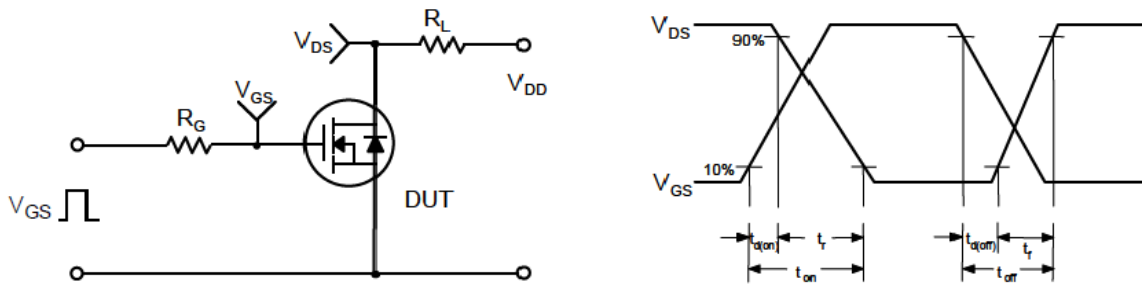

Unclamped Inductive Switching Test Circuit & Waveforms

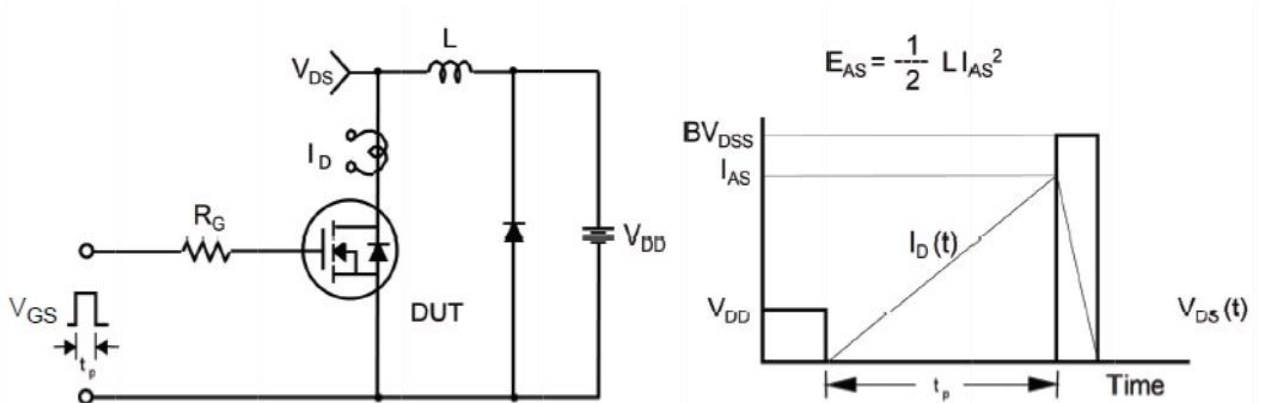

**Mechanical Dimensions for TO-252**

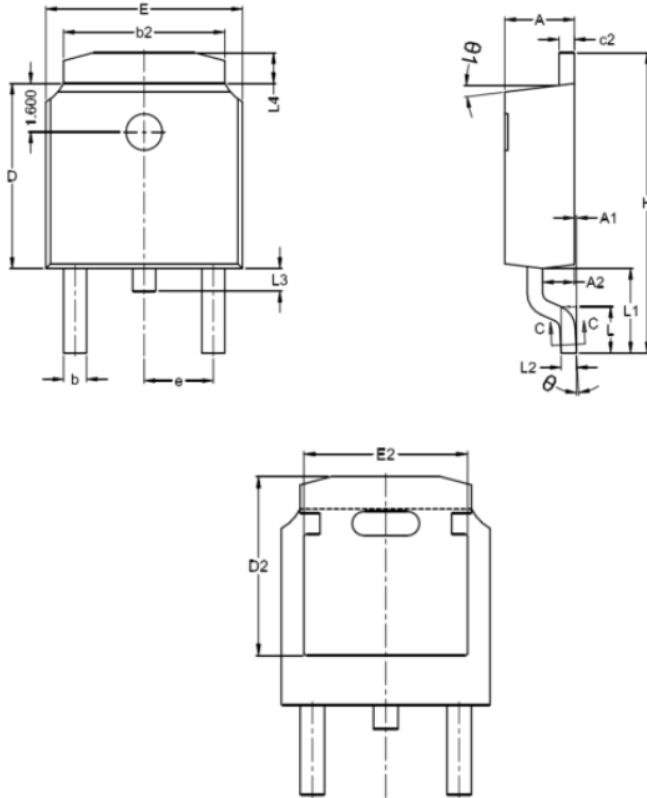

**COMMON DIMENSIONS**

SYMBOL	MM	
	MIN	MAX
A	2.10	2.50
A1	0	0.15
b	0.7	0.9
b2	5.13	5.54
c	0.44	0.65
c2	0.45	0.65
D	6.00	6.20
D2	5.37	5.78
E	6.30	6.90
E2	4.90	5.30
e	2.23	2.33
H	9.7	10.5
L	1.38	1.73
L1	2.58	3.00
L2	0.50	0.52
L3	0.60	1.00
L4	0.81	1.42

**Mechanical Dimensions for TO-220F**

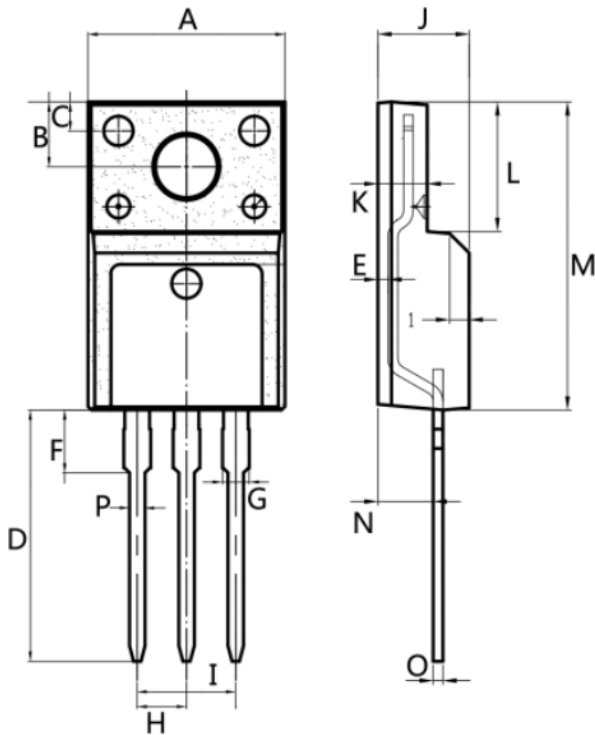

**COMMON DIMENSIONS**

SYMBOL	MM	
	MIN	MAX
A	9.95	10.36
B	2.95	3.55
C	1.25	1.6
D	12.64	13.5
E	0.40	0.60
F	2.80	3.80
G	1.14	1.58
H	2.44	2.64
I	4.88	5.26
J	4.50	4.90
K	2.34	2.80
L	6.48	6.90
M	15.40	16.07
N	2.66	3.50
O	0.40	0.64
P	0.70	0.94

## Ordering Information

Part	Package	Marking	Packing method
WMO5N50D1B	TO-252	WMO5N50D1B	Tape and reel
WML5N50D1B	TO-220F	WML5N50D1B	Tube

## Contact Information

No.1001, Shiwan(7) Road, Pudong District, Shanghai, P.R.China.201207

Tel: 86-21-50310888 Fax: 86-21-50757680 Email: market@way-on.com

WAYON website: <http://www.way-on.com>

For additional information, please contact your local Sales Representative.

 is registered trademarks of Wayon Corporation.

## Product Specification Statement

1.The product specification aims to provide users with a reference regarding various product parameters, performance, and usage. It presents certain aspects of the product's performance in graphical form and is intended solely for users to select product and make product comparisons, enabling users to better understand and evaluate the characteristics and advantages of the product. It does not constitute any commitment, warranty, or guarantee.

2.The product parameters described in the product specification are numerical values, characteristics, and functions obtained through actual testing or theoretical calculations of the product in an independent or ideal state. Due to the complexity of product applications and variations in test conditions and equipment, there may be slight fluctuations in parameter test values. WAYON shall not guarantee that the actual performance of the product when installed in the customer's system or equipment will be entirely consistent with the product specification, especially concerning dynamic parameters. It is recommended that users consult with professionals for product selection and system design. Users should also thoroughly validate and assess whether the actual parameters and performance when installed in their respective systems or equipment meet their requirements or expectations. Additionally, users should exercise caution in verifying product compatibility issues, and WAYON assumes no responsibility for the application of the product.

3.WAYON strives to provide accurate and up-to-date information to the best of our ability. However, due to technical, human, or other reasons, WAYON cannot guarantee that the information provided in the product specification is entirely accurate and error-free. WAYON shall not be held responsible for any losses or damages resulting from the use or reliance on any information in these product specifications. WAYON reserves the right to revise or update the product specification and the products at any time without prior notice, and the user's continued use of the product specification is considered an acceptance of these revisions and updates. Prior to purchasing and using the product, users should verify the above information with WAYON to ensure that the product specification is the most current, effective, and complete. If users are particularly concerned about product parameters, please consult WAYON in detail or request relevant product test reports. Any data not explicitly mentioned in the product specification shall be subject to separate agreement.

4.Users are advised to pay attention to the parameter limit values specified in the product specification and maintain a certain margin in design or application to ensure that the product does not exceed the parameter limit values defined in the product specification. This precaution should be taken to avoid exceeding one or more of the limit values, which may result in permanent irreversible damage to the product, ultimately affecting the quality and reliability of the system or equipment.

5.The design of the product is intended to meet civilian needs and is not guaranteed for use in harsh environments or precision equipment. It is not recommended for use in systems or equipment such as medical devices, aircraft, nuclear power, and similar systems, where failures in these systems or equipment could reasonably be expected to result in personal injury. WAYON shall assume no responsibility for any consequences resulting from such usage.

6.Users should also comply with relevant laws, regulations, policies, and standards when using the product specification. Users are responsible for the risks and liabilities arising from the use of the product specification and must ensure that it is not used for illegal purposes. Additionally, users should respect the intellectual property rights related to the product specification and refrain from infringing upon any third-party legal rights. WAYON shall assume no responsibility for any disputes or controversies arising from the above-mentioned issues in any form.