

SCHOTTKY BARRIER RECTIFIERS

Features

- 2A Schottky barrier diode
- Schottky barrier rectifier
- Guarding protection
- Low forward voltage
- Reverse energy tested
- High current capability
- Extremely low thermal resistance

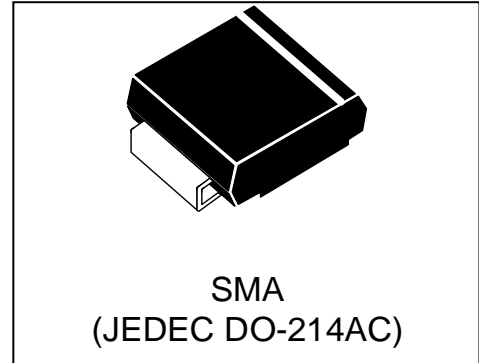

Mechanical Data

- Case: SMA(JEDECDO-214AC),molded plastic body
- Mounting position: any
- Polarity: Color band denotes cathode end

Absolute Maximum Ratings and Electronics characteristics

Ratings@25°C ambient temperature unless otherwise specified

Parameter	Symbol	WSR4002A	WSR6002A	WSR10002A	WSR15002A	WSR20002A	UNITS
Maximum repetitive peak reverse voltage	V_{RRM}	40	60	100	150	200	V
Maximum RMS voltage	V_{RMS}	28	42	70	105	140	V
Maximum DC blocking voltage	V_{DC}	40	60	100	150	200	V
Maximum average forward rectified current	$I_{F(AV)}$	2.0					A
Peak forward surge current 8.3ms single half-sine-wave	I_{FSM}	50					A
Maximum instantaneous forward voltage at $I_F=2.0A$	V_F	0.55	0.7	0.85	0.95		V
Maximum DC reverse current ($T_a=25^\circ C$) At rated DC blocking voltage ($T_a=100^\circ C$)	I_R	0.5 10		0.3 5			mA
Typical thermal resistance(junction to ambient)	$R_{\theta JA}$	80					$^\circ C/W$
Operating temperature range	T_J	-55 ~ +125					$^\circ C$
Storage temperature range	T_{STG}	-55 ~ +150					$^\circ C$

Typical characteristics (Ta=25°C, unless otherwise noted)

Fig. 1 - PEAK FORWARD SURGE CURRENT

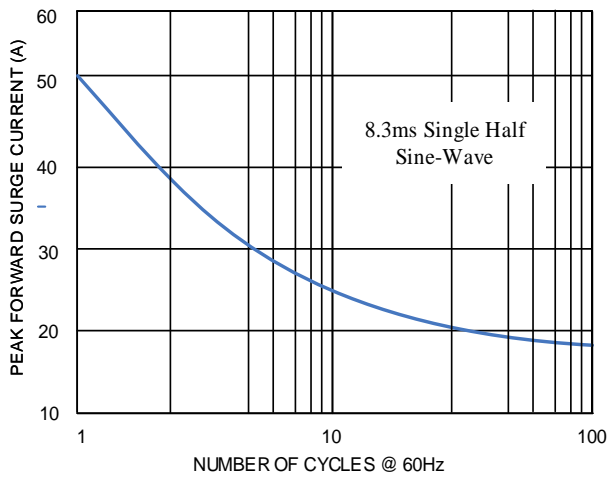

Fig. 2 - FORWARD CURRENT DERATING CURVE

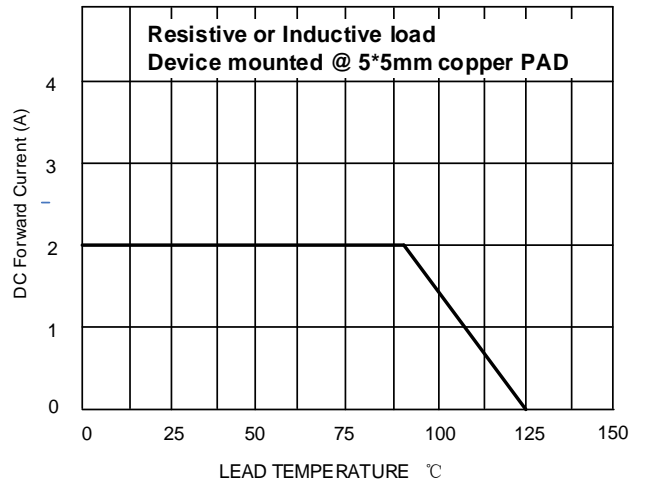

Fig.3 Typical Forward Characteristic

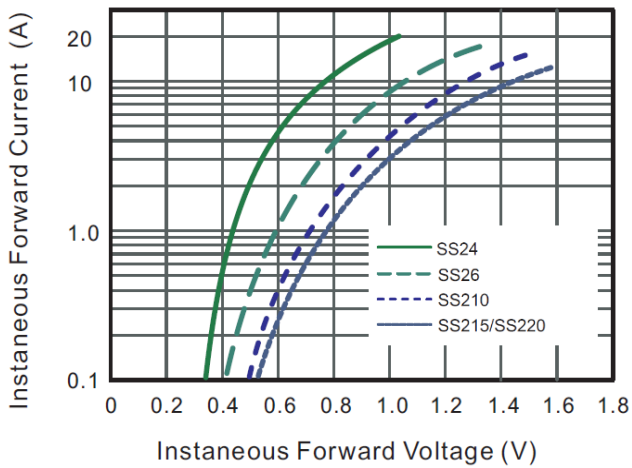

Fig.4- Typical Transient Thermal Impedance

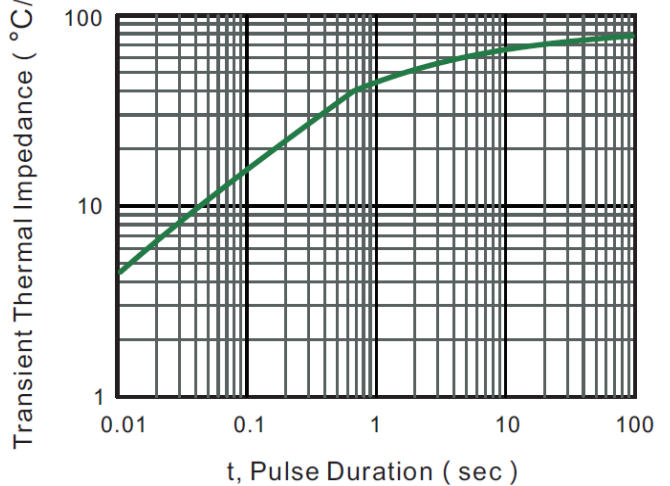
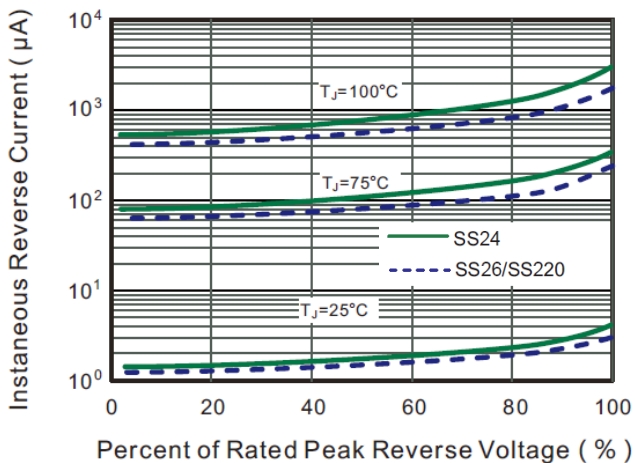
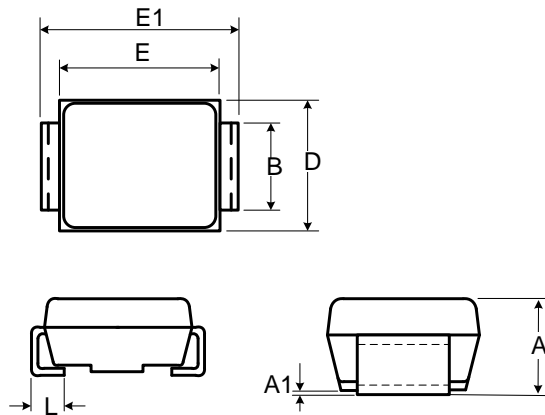

Fig.5 Typical Reverse Characteristics



Outline Drawing

Ref. (mm)	Millimeters	
	Min.	Max.
A	1.900	2.300
A1	-	0.300
B	1.250	1.650
E	3.950	4.750
E1	4.700	5.280
D	2.300	2.830
L	0.760	1.520



Recommended Solder Pad Layout

DIM(mm)	MILLIMETERS
A	2.30
B	1.80
C	2.10

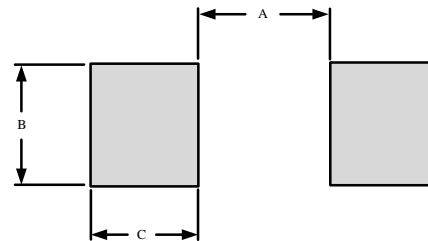

Marking Code

Part Number	WSR4002A	WSR6002A	WSR10002A	WSR15002A	WSR20002A
Marking Code	SS24	SS26	SS210	SS215	SS220

Package Information

Tape & Reel: 5000 pcs.

Tape and Reel Information

RD	Reel Dimensions	13 inch
W	Overall width of the carrier tape	12 mm
P1	Pitch between successive cavity centers	4 mm

Reel Dimensions Schematic diagram

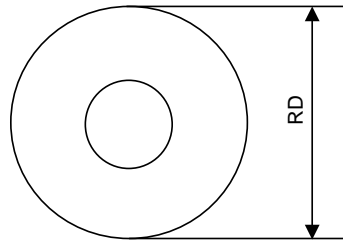

Tape Dimensions Schematic diagram

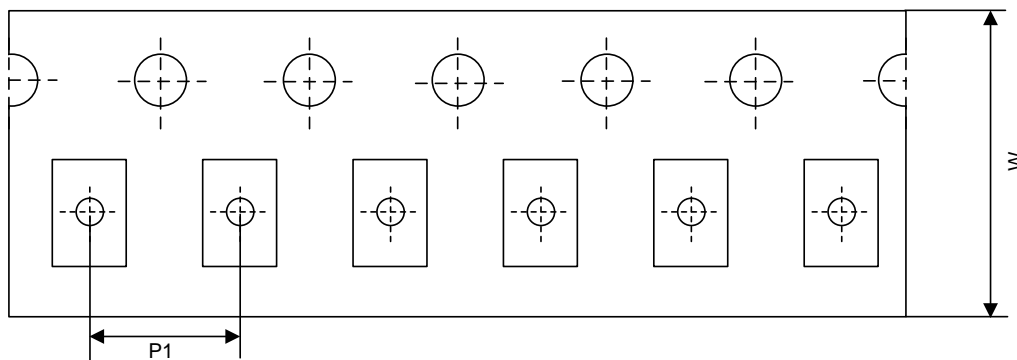

Quadrant Assignments for PIN1 Orientation in tape

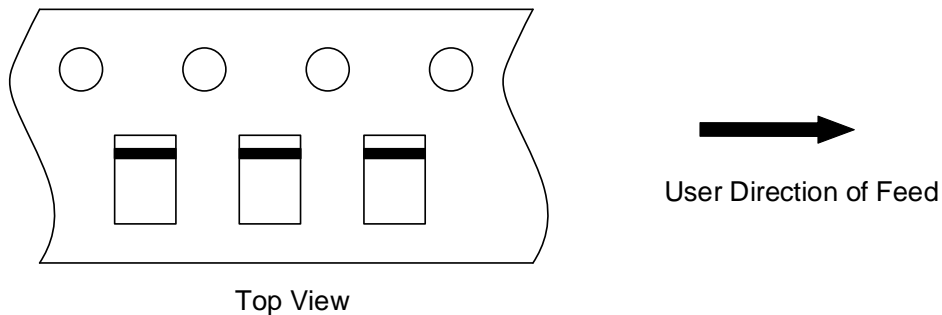

Contact Information

No.1001, Shiwan(7) Road, Pudong District, Shanghai, P.R.China.201207

Tel: 021-68969993 Fax: 86-21-50757680 Email: market@way-on.com

WAYON website: <http://www.way-on.com>

For additional information, please contact your local Sales Representative.

WAYON® is registered trademarks of Wayon Corporation.

*Specifications are subject to change without notice.
The device characteristics and parameters in this data sheet can and do vary in different applications and actual device performance may vary over time.
Users should verify actual device performance in their specific applications.*