



WS6413EC

Transient Voltage Suppressor

Features

- Solid-state silicon-avalanche technology
- Low operating and clamping voltage
- Up to four I/O lines of protection
- Low leakage
- Low operating voltage:3.3V

IEC COMPATIBILITY (EN61000-4)

- IEC 61000-4-2 (ESD) ±15kV (air), ±12kV (contact)
- IEC 61000-4-4 (EFT) 40A (5/50ns)
- IEC 61000-4-5 (Lightning) 5A (8/20µs)

Mechanical Characteristics

- DFN2510-10L package
- Marking: Marking Code
- Packaging: Tape and Reel
- RoHS Compliant & HF
- Device meets MSL1 requirement

Circuit Diagram

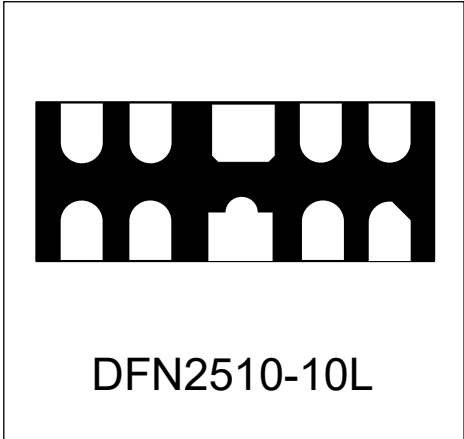
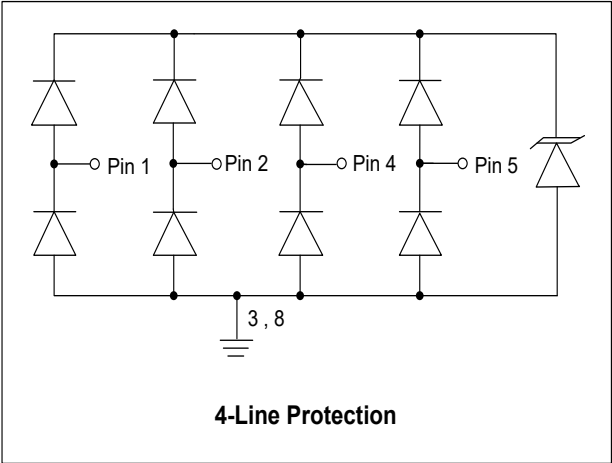

Applications

- USB2.0,USB 3.0 and USB 3.1
- HDMI 1.3, HDMI 1.4
- SATA and eSATA
- DVI
- IEEE 1394
- PCI Express
- Portable Electronics and Notebooks

Schematic & PIN Configuration

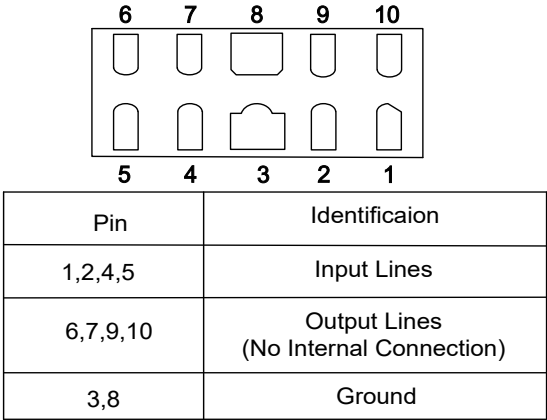

Absolute Maximum Rating

Rating	Symbol	Value	Units
Peak Pulse Power ($t_p = 8/20\mu s$)	P_{PP}	25	W
Peak Pulse Current ($t_p = 8/20\mu s$)	I_{pp}	5	A
Operating Temperature	T_J	-55 to + 125	$^{\circ}C$
Storage Temperature	T_{STG}	-55 to +150	$^{\circ}C$

Electrical Parameters

Symbol	Parameter
I_{PP}	Reverse Peak Pulse Current
V_C	Clamping Voltage
V_{RWM}	Reverse Stand-Off Voltage
I_{BR}	Reverse Breakdown Current
I_R	Reverse Leakage Current
V_{BR}	Reverse Breakdown Voltage
V_T	Reverse Trigger Voltage
I_T	Reverse Trigger Current
V_H	Reverse Holding Voltage
I_H	Reverse Holding current
V_F	Forward Voltage
I_F	Forward Current

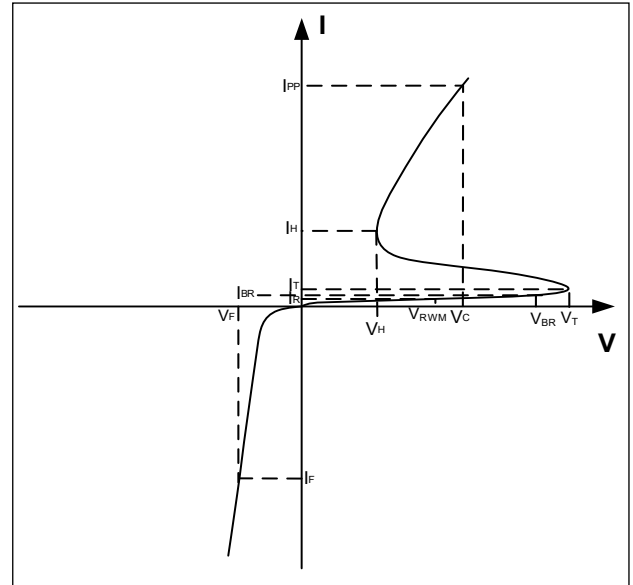

Electrical Characteristics(T=25 $^{\circ}C$ unless otherwise noted)

WS6413EC						
Parameter	Symbol	Conditions	Minimum	Typical	Maximum	Units
Reverse Stand-Off Voltage	V_{RWM}	Any I/O pin to ground			3.3	V
Reverse Breakdown Voltage	V_{BR}	$I_t = 1mA$ Any I/O pin to ground	4			V
Reverse Leakage Current	I_R	$V_{RWM} = 3.3V$ Any I/O pin to ground			500	nA
Holding current	I_H	$T=25^{\circ}C$		9		mA
Clamping Voltage	V_C	$I_{pp}=5A, t_p=8/20\mu s$ Any I/O pin to ground		3	5	V
ESD Clamping Voltage ¹	V_C	$I_{pp} = 4A,$ $t_p = 0.2/100ns$ (TLP)		2.7		V
ESD Clamping Voltage ¹	V_C	$I_{pp} = 16A,$ $t_p = 0.2/100ns$ (TLP)		5.4		V
Dynamic Resistance ^{1,2}	R_{DYN}	TLP=0.2/100ns		0.23		Ω
Junction Capacitance	C_j	$V_R = 2.5V, f = 1MHz$ I/O pin to GND		0.35	0.5	pF
		$V_R = 2.5V, f = 1MHz$ Between I/O pins,		0.18	0.25	pF

Notes : 1、 TLP Setting : $t_p=100ns, t_r=0.2ns, I_{TLP}$ and V_{TLP} sample window: $t_1=70ns$ to $t_2=90ns$.

2、 Dynamic resistance calculated from $I_{PP}=4A$ to $I_{PP}=16A$ using "Best Fit".

Typical Characteristics

Figure 1: Peak Pulse Power vs. Pulse Time

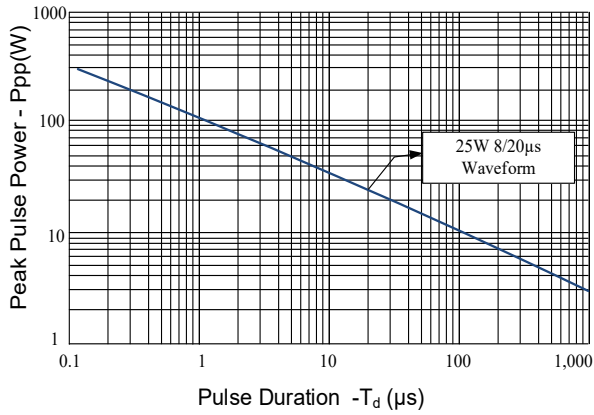

Figure 2: Power Derating Curve

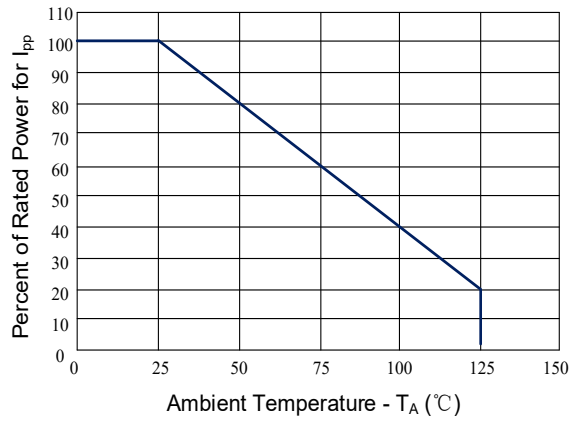

Figure 3: Clamping Voltage vs. Peak Pulse Current

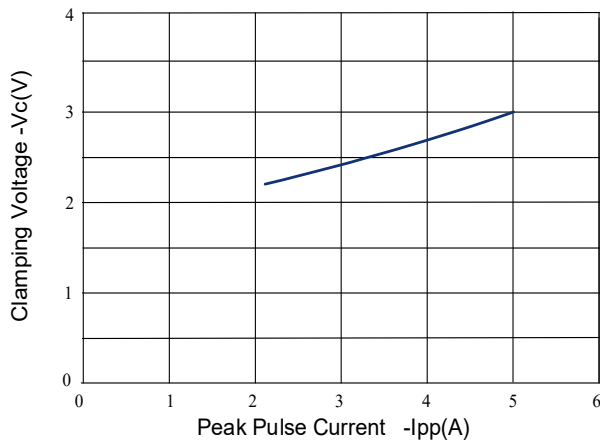

Figure 4: Normalized Junction Capacitance vs. Reverse Voltage

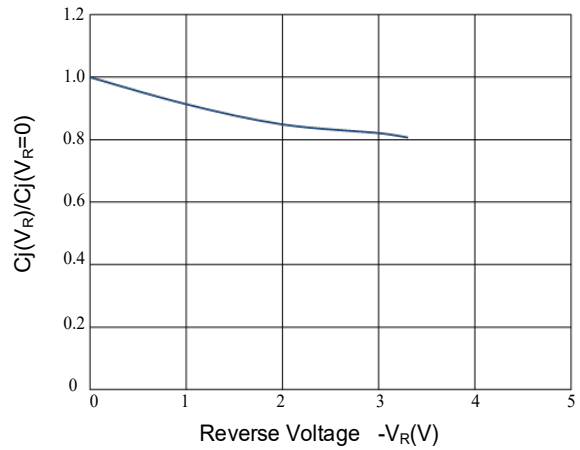

Figure 5: 8/20μs Pulse Waveform

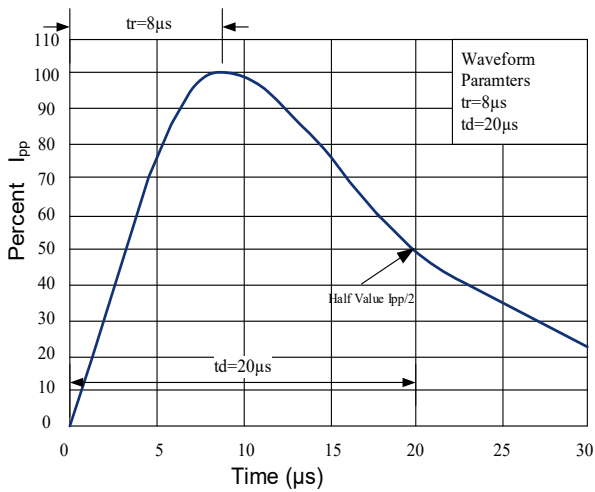
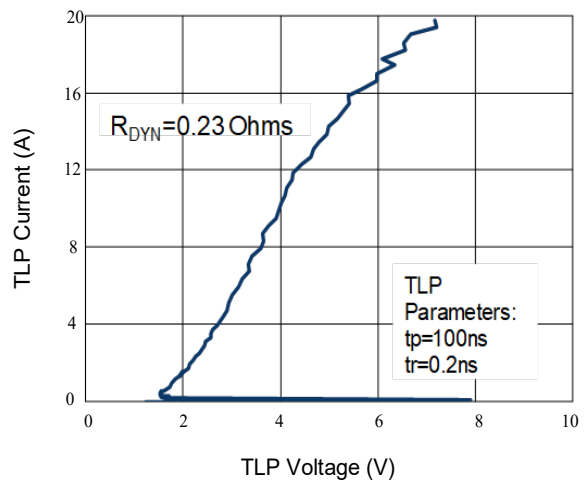
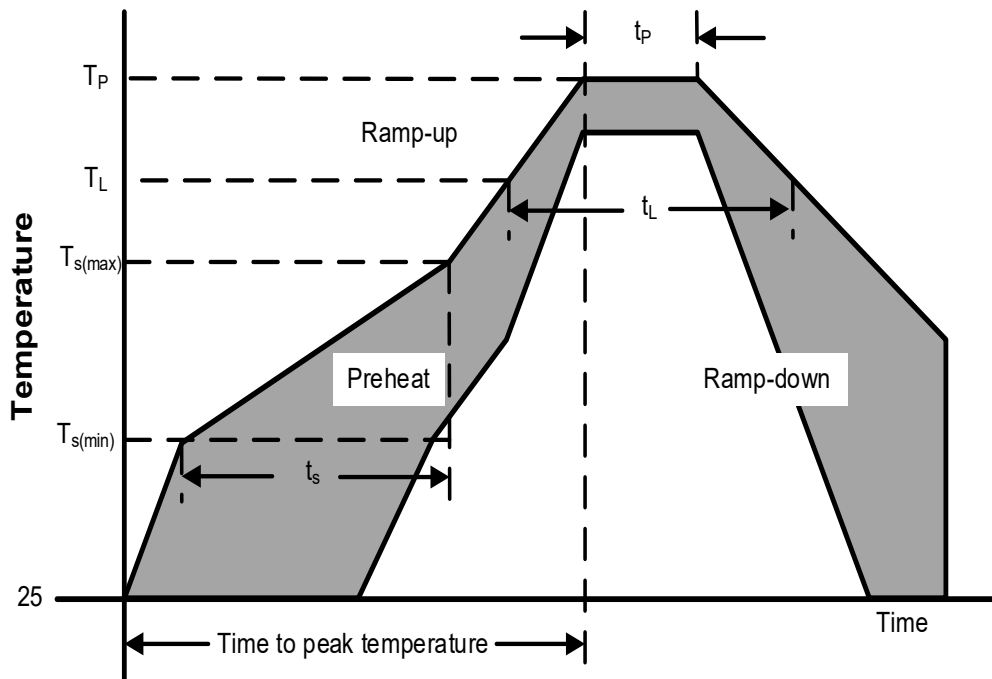

Figure 6: TLP I-V Curve



Soldering Parameters

Reflow Condition		Pb – Free assembly
Pre Heat	Temperature Min ($T_{s(min)}$)	150°C
	Temperature Max ($T_{s(max)}$)	200°C
	Time (min to max) (t_s)	60 – 190 secs
Average ramp up rate (Liquidus Temp) (T_L) to peak		5°C/second max
$T_{s(max)}$ to T_L — Ramp-up Rate		5°C/second max
Reflow	Temperature (T_L) (Liquidus)	217°C
	Temperature (t_L)	60 – 150 seconds
Peak Temperature (T_P)		260+0/-5 °C
Time within actual peak Temperature (t_p)		20 – 40 seconds
Ramp-down Rate		5°C/second max
Time 25°C to peak Temperature (T_P)		8 minutes Max.
Do not exceed		280°C



Tape And Reel Information

Reel Dimensions

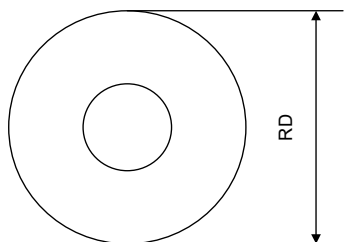

Tape Dimensions

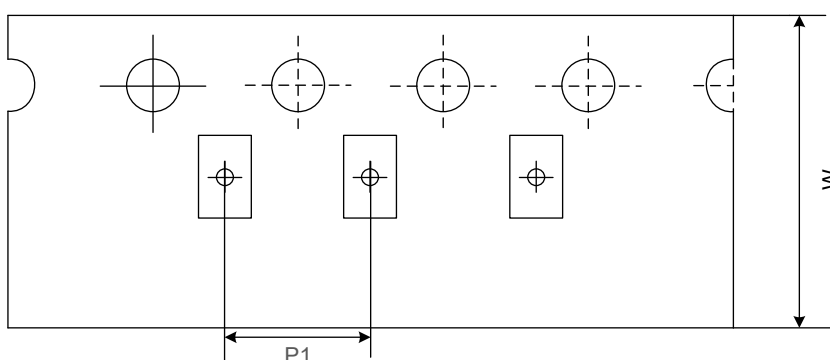

Quadrant Assignments For PIN1 Orientation In Tape

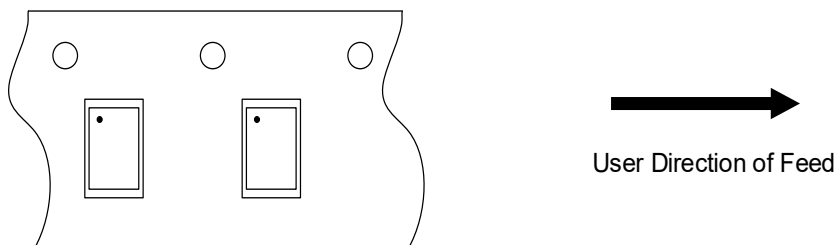

RD	Reel Dimensions	7 inch
W	Overall width of the carrier tape	8 mm
P1	Pitch between successive cavity centers	4mm

Outline Drawing –DFN2510-10L

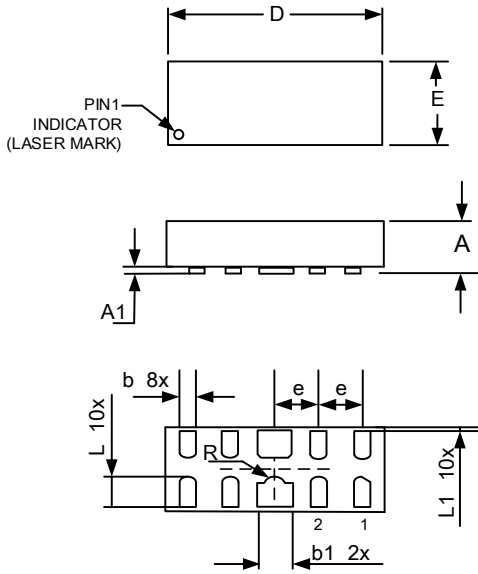

DFN2.5x1-10L

DIM	MILLIMETERS		
	MIN	NOM	MAX
A	0.450	-	0.550
A1	0.025	0.050	0.075
D	2.450	2.500	2.550
E	0.950	1.000	1.050
b	0.150	0.200	0.250
b1	0.150	0.200	0.250
L	0.320	0.370	0.420
L1	0.000	0.030	0.060
R	0.100 REF		
e	0.500 BSC		

DIMENSIONS		
DIM	INCHES	MILLIMETERS
C	0.034	0.875
G	0.008	0.20
P	0.020	0.50
P1	0.039	1.00
X	0.010	0.25
X1	0.018	0.45
Y	0.027	0.675
Y1	0.061	1.55

Notes:
Controlling Dimension: Millimeter.

Marking Codes

Part Number	WS6413EC
Marking Code	<div style="border: 1px solid black; display: inline-block; padding: 5px; margin-bottom: 5px;"> 43KX </div> <p style="margin: 0;">43K= Specific Device Code X=Month Code</p>

Package Information

Qty: 3k/Reel

CONTACT INFORMATION

No.1001, Shiwan (7) Road, Pudong District, Shanghai, P.R.China.201207

Tel: 86-21-68969993 Fax: 86-21-50757680 Email: market@way-on.com

WAYON website: <http://www.way-on.com>

For additional information, please contact your local Sales Representative.

WAYON ® is registered trademark of WAYON Corporation.

Specifications are subject to change without notice.
The device characteristics and parameters in this data sheet can and do vary in different applications and actual device performance may vary over time.
Users should verify actual device performance in their specific applications.