

## Description

The WOC-816X is a photoelectric coupler composed of light-emitting diode and phototransistor. It is packaged in a 4-pin package at DIP、DIP-M、DIP-S1.



## Features

- Current transfer ratio(CTR : MIN. 50% at  $I_F = 5\text{mA}$ ,  $V_{CE} = 5\text{V}$ )
- High input-output isolation voltage( $V_{iso} = 5,000\text{Vrms}$ )
- Operating Temperature:  $-55^{\circ}\text{C} \sim 110^{\circ}\text{C}$
- RoHS
- MSL1

## Applications

- Programmable controllers
- Switching power supply, intelligent meter
- Home appliances: such as air conditioners, fans, water heaters, etc

## Schematic & PIN Configuration

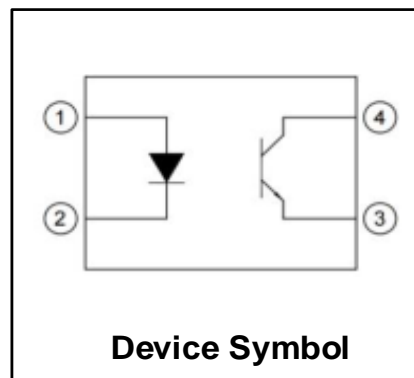

### Pin Configuration

1. Anode
2. Cathode
3. Emitter
4. Collector

Product Nomenclature

WOC -816 X - X X - X X X - XX  
 ① ② ③ ④ ⑤ ⑥ ⑦

Designation:

WOC =WAYON Optocoupler

816= Product Series

- ① = Lead form option(S1,M,NONE)<sup>(1)</sup>
- ② = CTR Rank(A,B,C,D,E)<sup>(2)</sup>
- ③ = Tape and Reel option(TP,TP1,NONE)<sup>(3)</sup>
- ④ = Lead frame Material(F,NONE)<sup>(4)</sup>
- ⑤ = VDE order option(fixed code "V")
- ⑥ = Halogen free option(fixed code"G")
- ⑦ = Customer code

Notes

1. Lead form option:

Symbol	Description
S1	DIP4-S1
M	DIP4-M
NONE	DIP4 Normal

2. CTR Rank:

Symbol	Description
A,B,C,D	CTR Rank
NONE	No Rank

3. Tape and Reel option:

Symbol	Description
TP&TP1	Tape and Reel Type
NONE	DIP Type

4. Lead frame Material

Symbol	Description
F	Iron
NONE	Copper

## Marking Information

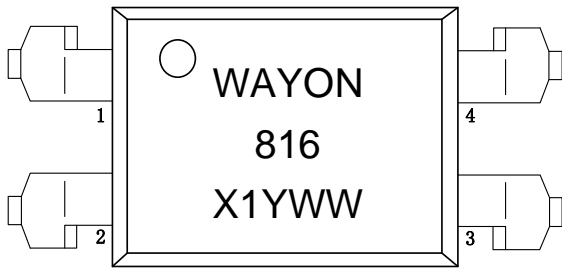

Designation:

WAYON: denotes WAYON

816 : denotes Device

X : denotes CTR Rank

1Y : denotes year code

WW: denotes week code

## Maximum Ratings

Parameter		Symbol	Value	Unit
Input	Forward Current	$I_F$	50	mA
	Reverse Voltage	$V_R$	6	V
	Power Dissipation	$P$	70	mW
	Peak Forward Current (100 $\mu$ s pulse, 100Hz)	$I_{FP}$	1	A
	Thermal Resistance Junction-Ambient	$R_{thJ-A}$	325	$^{\circ}C/W$
	Thermal Resistance Junction-Case	$R_{thJ-C}$	200	$^{\circ}C/W$
Output	Collector - Emitter Voltage	$V_{CEO}$	80	V
	Emitter - Collector Voltage	$V_{ECO}$	7	V
	Collector Current	$I_C$	50	mA
	Collector Power Dissipation	$P_C$	150	mW
Operating temperature range		$T_{op}$	-55 ~ 110	$^{\circ}C$
Storage temperature range		$T_{stg}$	-55 ~ 125	$^{\circ}C$
Total Power consumption		$P(W)$	200	mW
Isolation Voltage <sup>(1)</sup>		$V_{iso}$	5000	Vrms
Soldering Temperature <sup>(2)</sup>		$T_{sol}$	260	$^{\circ}C$

Notes:

(1). AC for 1 minute, R.H.= 40 ~ 60% R.H. In this test, pins 1, 2 are shorted together, and pins 3, 4 are shorted together.

(2). For 10 seconds

## Electrical Optical Characteristics (TA=25°C)

Parameter		Symbol	Conditions	Min.	Typ.	Max.	Unit
Input	Forward Voltage	$V_F$	$I_F = 20\text{mA}$	-	1.2	1.4	V
	Reverse Current	$I_R$	$V_R = 4\text{V}$	-	-	10	$\mu\text{A}$
	Terminal Capacitance	$C_t$	$V = 0, f = 1\text{KHz}$	-	30	250	pF
Output	Collector Dark Current	$I_{CEO}$	$V_{CE} = 20\text{V}, I_F = 0$	-	-	100	nA
	Collector-Emitter Breakdown Voltage	$BV_{CEO}$	$I_C = 0.1\text{mA}, I_F = 0$	80			V
	Emitter-Collector Breakdown Voltage	$BV_{ECO}$	$I_E = 10\mu\text{A}, I_F = 0$	7			V
Collector-Emitter Saturation Voltage		$V_{CE(sat)}$	$I_F = 20\text{mA}, I_C = 1\text{mA}$		0.1	0.2	V
Isolation Resistance		$R_{ISO}$	DC500V, 40~60%RH	$5 \times 10^{10}$	$1 \times 10^{11}$	-	$\Omega$
Floating Capacitance		$C_f$	$V = 0, f = 1\text{MHz}$		0.6	1	pF
Cut-off Frequency		$f_c$	$V_{CE} = 5\text{V}, I_C = 2\text{mA}, R_L = 100\Omega, -3\text{dB}$	80			kHz
Response Time (Rise)		$t_r$	$V_{CE} = 2\text{V}, I_C = 2\text{mA}, R_L = 100\Omega$		4	18	$\mu\text{s}$
Response Time (Fall)		$t_r$			3	18	$\mu\text{s}$

## Rank Table Of Current Transfer Ratio (CTR=IC/IF x 100%)

Rank Code	Symbol	Min	Max	Condition
NONE	CTR	50	600	$I_F = 5\text{mA}, V_{CE} = 5\text{V}, T_a = 25^\circ\text{C}$
A		80	160	
B		130	260	
C		200	400	
D		300	600	

### Characteristics Curves

Fig.1 Relative Current Transfer Ratio vs. Forward Current

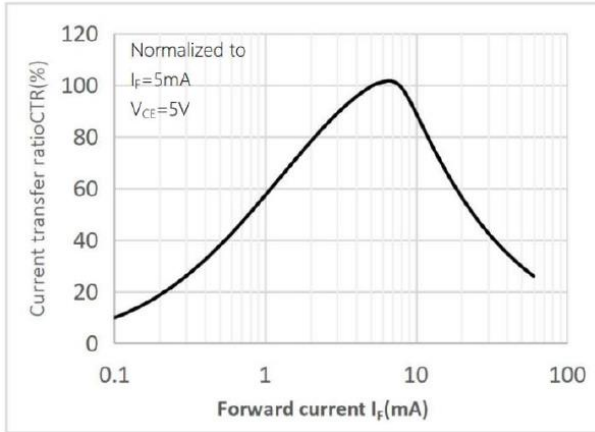

Fig.2 Forward Current vs. Forward Voltage

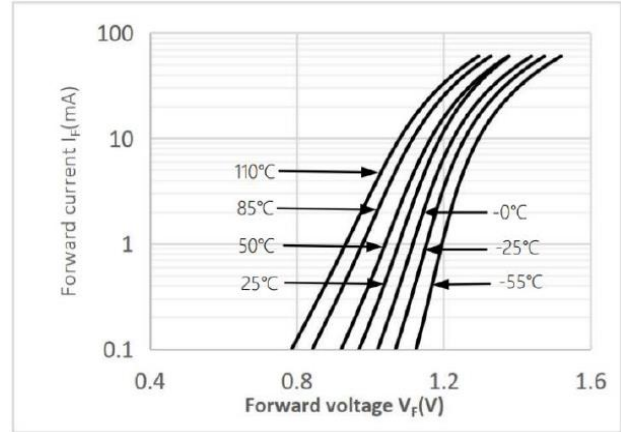

Fig.3 Collector Current vs. Collector-emitter Voltage

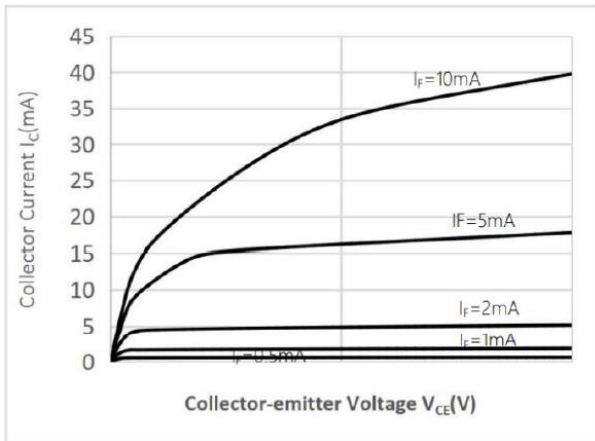

Fig.4 Relative Current Transfer Ratio vs. Ambient Temperature

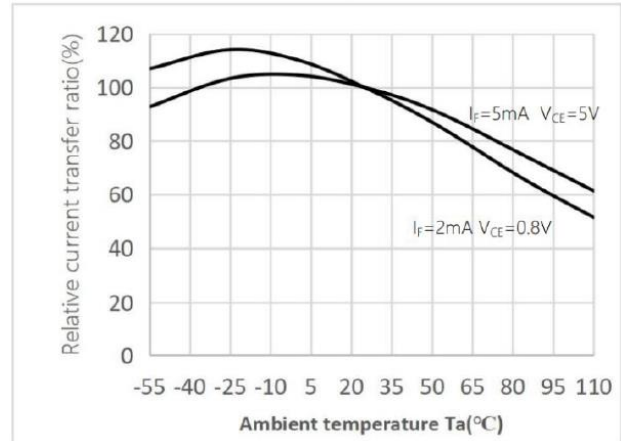

Fig.5 Collector-emitter Saturation Voltage vs. Ambient Temperature

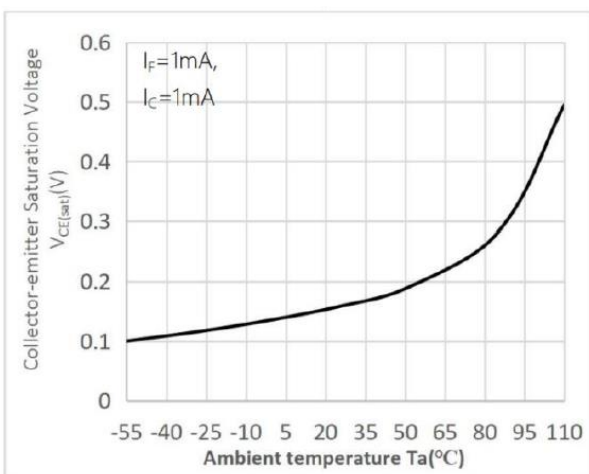

Fig.6 Collector Dark Current vs Ambient Temperature

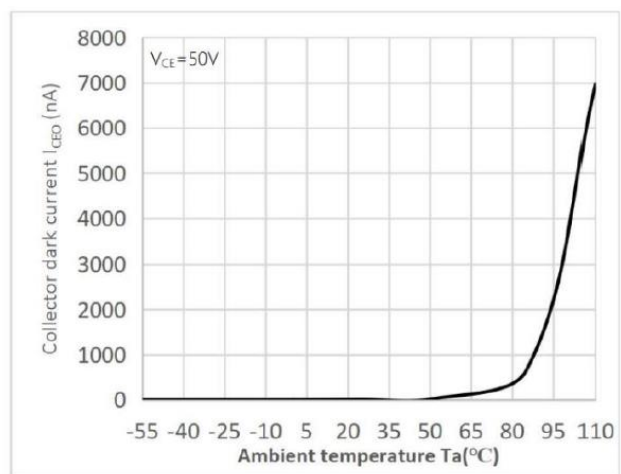

Fig.7 Response Time vs. Load Resistance

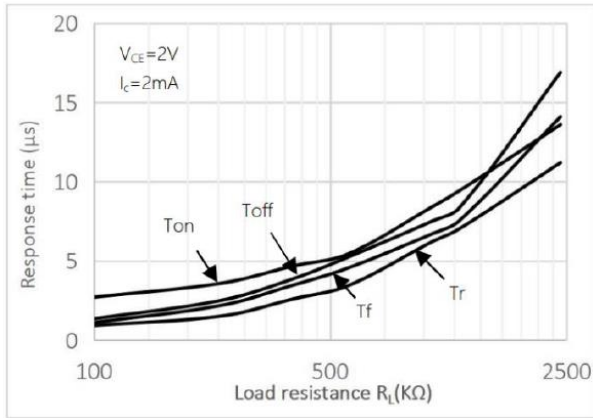

Fig.8 Frequency Response

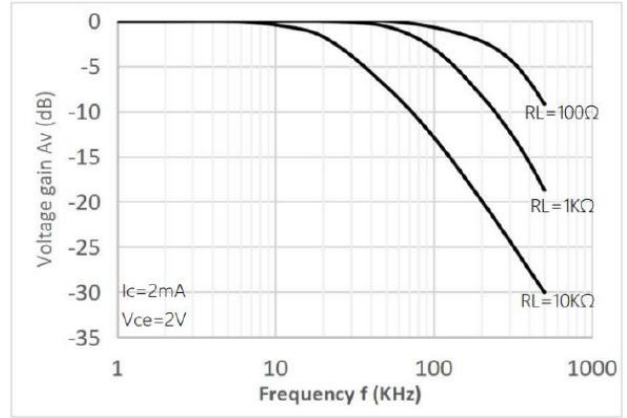

Fig.9 Collector-emitter Saturation Voltage vs. Forward Current

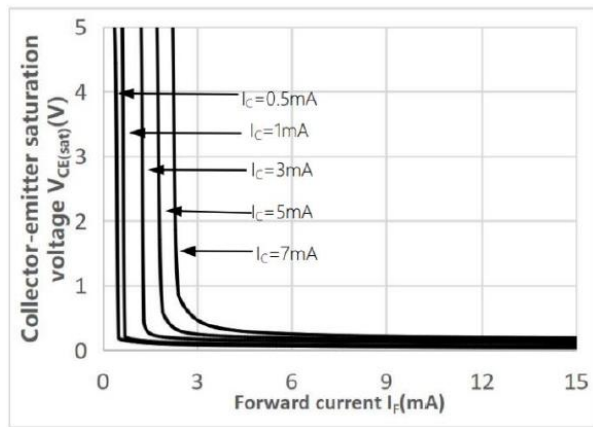
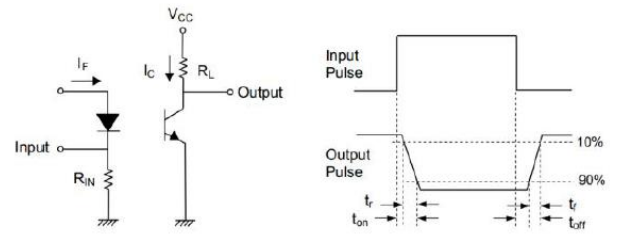
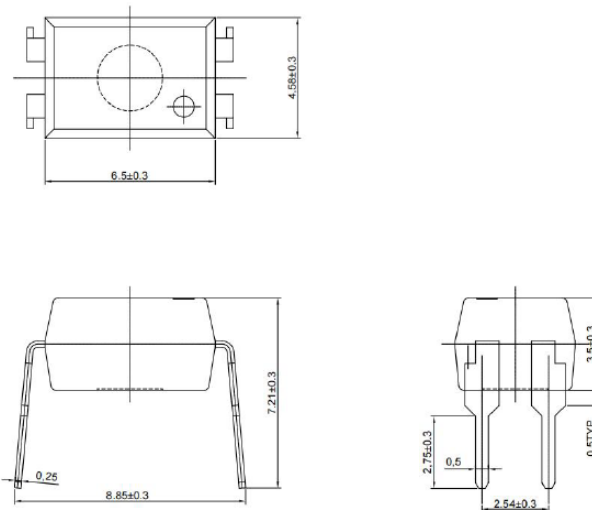

Fig.10 Switching Time Test Circuit & Waveforms



Outline Dimensions

DIP Normal Type:



DIP M Type:

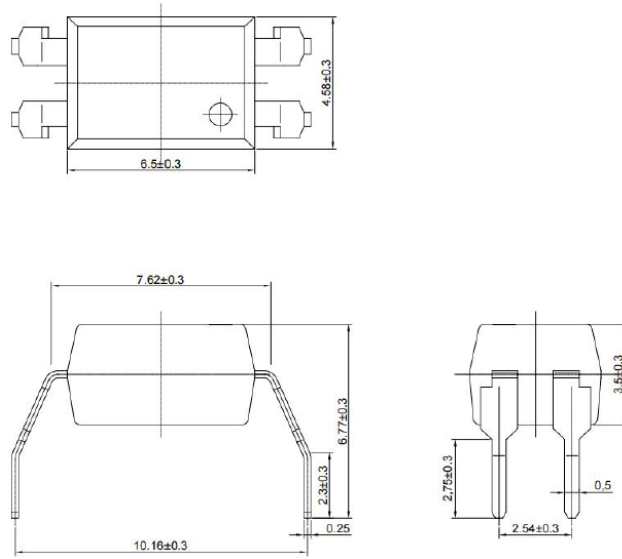

SMD S1 Type:

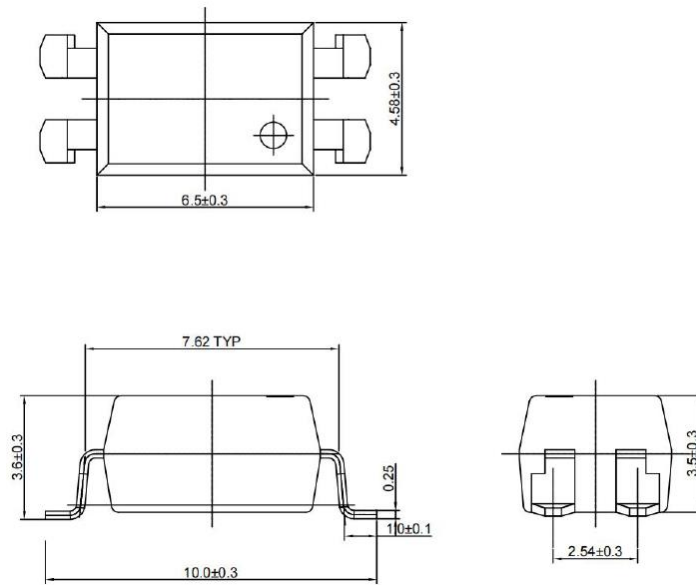

Unit: mm

Tolerance:  $\pm 0.1$  mm

### Recommended solder pad Design

For S1 type:

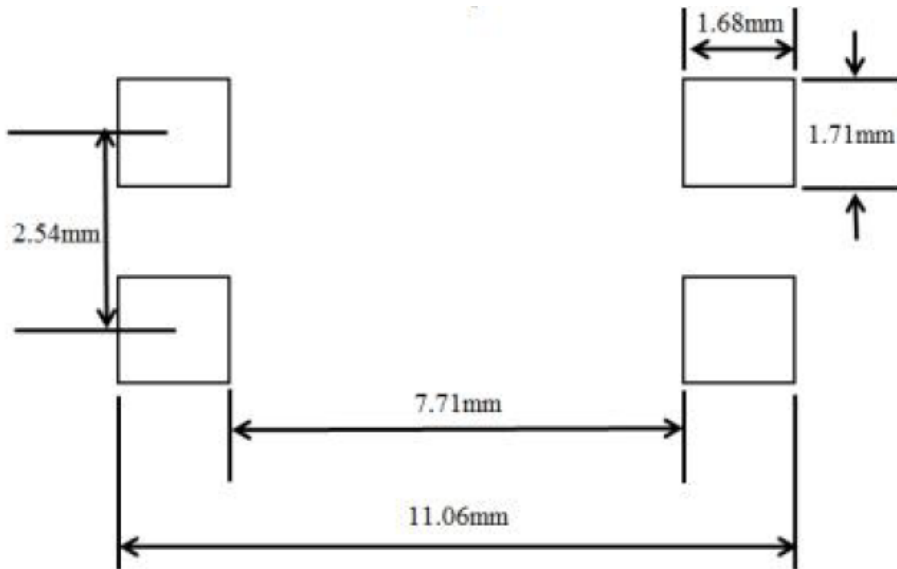

Unit: mm

Tolerance:  $\pm 0.1$ mm



## Temperature Profile Of Soldering

### IR Reflow soldering(JEDEC-STD-020D compliant)

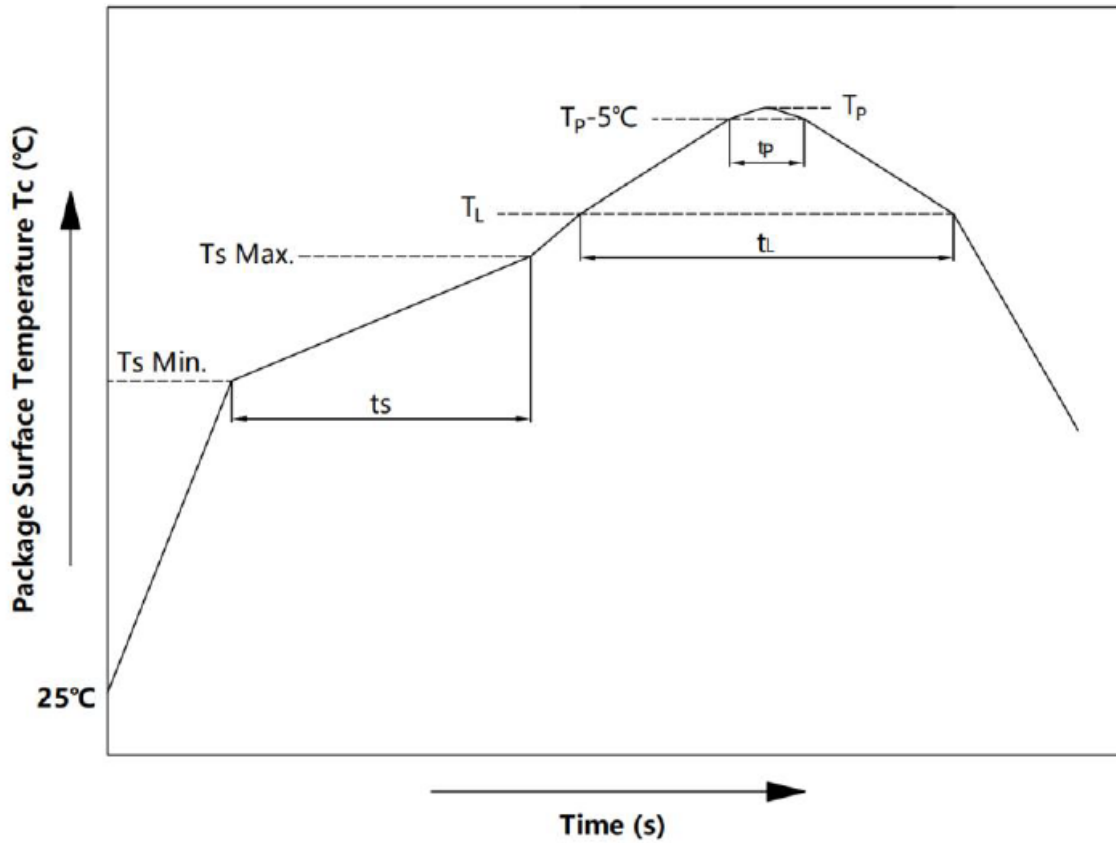

Item	Symbol	Min.	Max.	Unit
Preheat Temperature	$T_s$	150	200	°C
Preheat Time	$t_s$	60	120	s
Ramp-Up Rate ( $T_L$ to $T_P$ )	-	-	3	°C /s
Liquidus Temperature	$T_L$	217		°C
Time Above $T_L$	$t_L$	60	150	s
Peak Temperature	$T_P$	-	260	°C
Time During Which $T_c$ Is Between ( $T_P-5$ ) and $T_P$	$t_p$	-	30	s
Ramp-down Rate( $T_P$ to $T_L$ )	-	3	6	°C /s

Note:

One time soldering reflow is recommended within the condition of temperature and time profile shown below. Do not solder more than three times.

### Wave Soldering(JEDEC22A111 compliant)

One time soldering is recommended within the condition.

Temperature:  $260 \pm 0/-5^\circ\text{C}$ .

Time: 10 sec.

Preheat temperature: 25 to  $140^\circ\text{C}$ .

Preheat time: 30 to 80 sec.

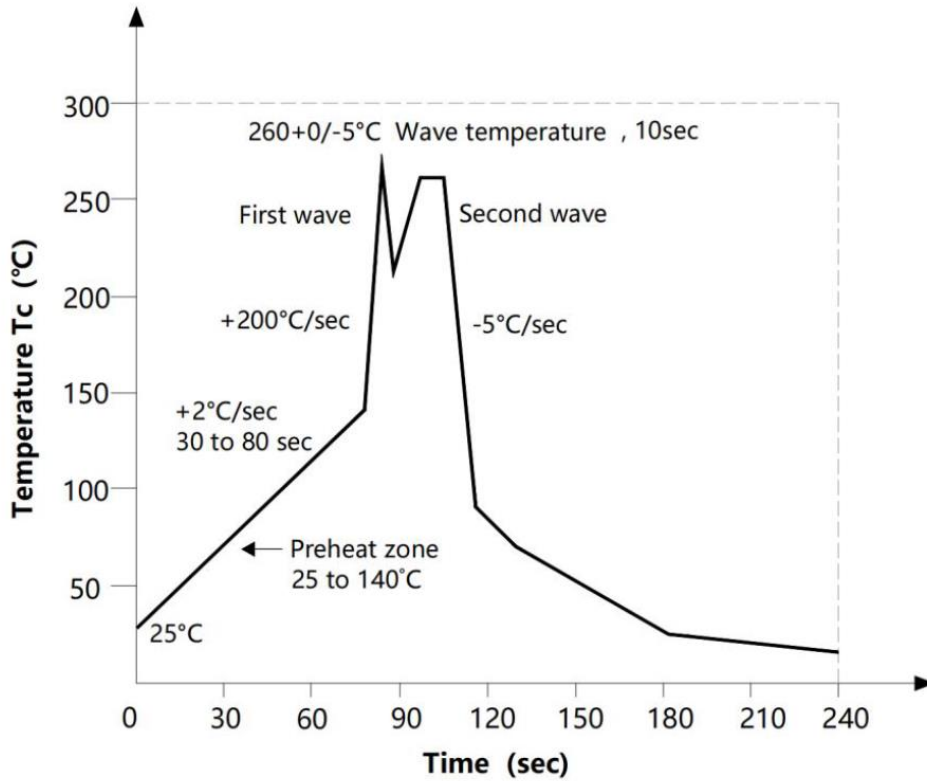

### Hand soldering by soldering iron

Allow single lead soldering in every single process. One time soldering is recommended.

Temperature:  $380 \pm 0/-5^\circ\text{C}$

Time: 3 sec max

Packing  
Tape and Reel

Option TP:

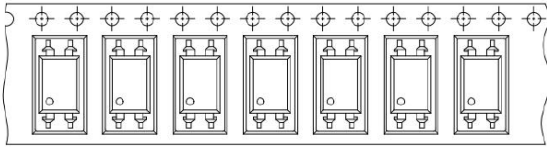

Option TP1:

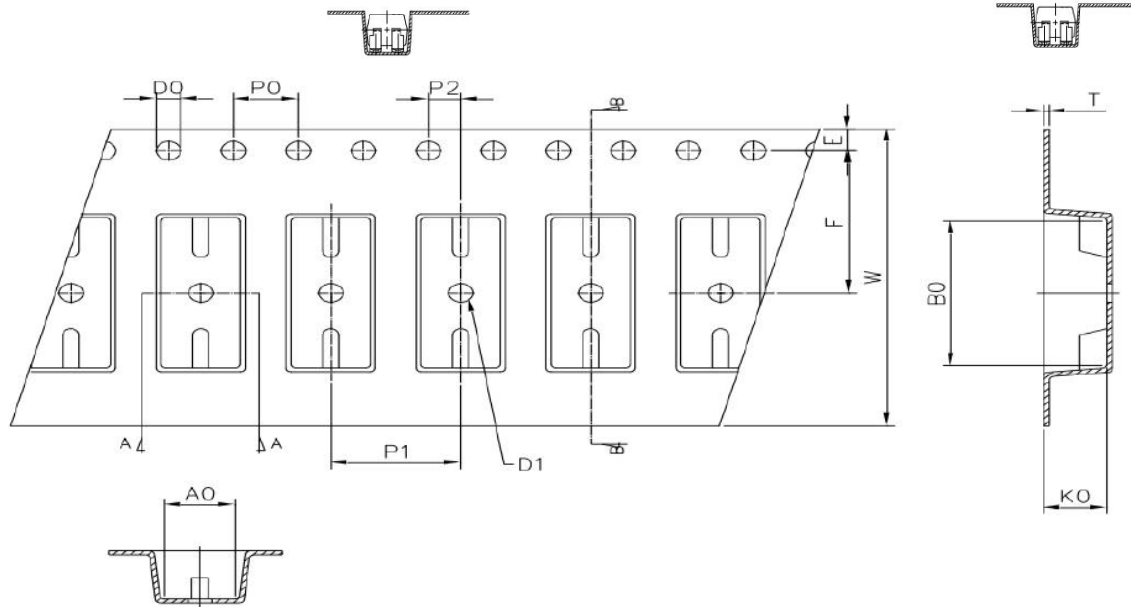
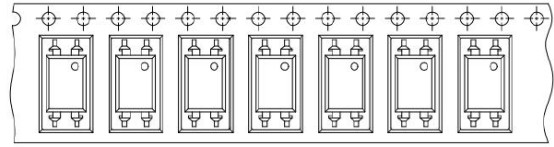

Deminsion/mm	W	E	F	P0	P1	P2
Package type: DIP S1	16±0.2	1.75±0.1	7.5±0.1	4±0.1	8±0.1	2±0.1

Deminsion/mm	A0	B0	D0	D1	K0	T
Package type: DIP S1	4.6±0.1	10.4±0.1	1.5±0.1	1.5±0.1	4.2±0.1	0.4±0.1

Package type: DIP S1	Reel	Inner carton	Outer carton
QTY/PCS	2K/reel	4K(2 reels)	40K

Tape and Tube

Package type: DIP Normal&M	Tube	Inner carton	Outer carton
QTY/PCS	100	5K(50 Tubes)	50K

CONTACT INFORMATION

No.1001, Shiwan (7) Road, Pudong District, Shanghai, P.R.China.201207

Tel: 86-21-68969993 Fax: 86-21-50757680 Email: [market@way-on.com](mailto:market@way-on.com)

WAYON website: <http://www.way-on.com>

For additional information, please contact your local Sales Representative.

**WAYON**® is registered trademark of WAYON Corporation.

---

### Product Specification Statement

1. The product specification aims to provide users with a reference regarding various product parameters, performance, and usage. It presents certain aspects of the product's performance in graphical form and is intended solely for users to select product and make product comparisons, enabling users to better understand and evaluate the characteristics and advantages of the product. It does not constitute any commitment, warranty, or guarantee.
2. The product parameters described in the product specification are numerical values, characteristics, and functions obtained through actual testing or theoretical calculations of the product in an independent or ideal state. Due to the complexity of product applications and variations in test conditions and equipment, there may be slight fluctuations in parameter test values. WAYON shall not guarantee that the actual performance of the product when installed in the customer's system or equipment will be entirely consistent with the product specification, especially concerning dynamic parameters. It is recommended that users consult with professionals for product selection and system design. Users should also thoroughly validate and assess whether the actual parameters and performance when installed in their respective systems or equipment meet their requirements or expectations. Additionally, users should exercise caution in verifying product compatibility issues, and WAYON assumes no responsibility for the application of the product.
3. WAYON strives to provide accurate and up-to-date information to the best of our ability. However, due to technical, human, or other reasons, WAYON cannot guarantee that the information provided in the product specification is entirely accurate and error-free. WAYON shall not be held responsible for any losses or damages resulting from the use or reliance on any information in these product specifications. WAYON reserves the right to revise or update the product specification and the products at any time without prior notice, and the user's continued use of the product specification is considered an acceptance of these revisions and updates. Prior to purchasing and using the product, users should verify the above information with WAYON to ensure that the product specification is the most current, effective, and complete. If users are particularly concerned about product parameters, please consult WAYON in detail or request relevant product test reports. Any data not explicitly mentioned in the product specification shall be subject to separate agreement.
4. Users are advised to pay attention to the parameter limit values specified in the product specification and maintain a certain margin in design or application to ensure that the product does not exceed the parameter limit values defined in the product specification. This precaution should be taken to avoid exceeding one or more of the limit values, which may result in permanent irreversible damage to the product, ultimately affecting the quality and reliability of the system or equipment.
5. The design of the product is intended to meet civilian needs and is not guaranteed for use in harsh environments or precision equipment. It is not recommended for use in systems or equipment such as medical devices, aircraft, nuclear power, and similar systems, where failures in these systems or equipment could reasonably be expected to result in personal injury. WAYON shall assume no responsibility for any consequences resulting from such usage.
6. Users should also comply with relevant laws, regulations, policies, and standards when using the product specification. Users are responsible for the risks and liabilities arising from the use of the product specification and must ensure that it is not used for illegal purposes. Additionally, users should respect the intellectual property rights related to the product specification and refrain from infringing upon any third-party legal rights. WAYON shall assume no responsibility for any disputes or controversies arising from the above-mentioned issues in any form.