

Description

The WOC-10XX is a photoelectric coupler composed of light-emitting diode and phototransistor. It is packaged in a 4-pin LSOP 4 package.



Features

- Current transfer ratio
(CTR : MIN. 50% at $I_F = 5\text{mA}$, $V_{CE} = 5\text{V}$)
(CTR: 63~320% at $I_F = 10\text{mA}$, $V_{CE} = 5\text{V}$)
- High input-output isolation voltage($V_{iso} = 5,000\text{Vrms}$)
- 8mm long creepage distance
- Operating Temperature: $-55^\circ\text{C} \sim 110^\circ\text{C}$
- Safety approval
- RoHS
- MSL1

Applications

- Programmable controllers
- Switching power supply, intelligent meter
- Home appliances: such as air conditioners, fans, water heaters, etc

Schematic & PIN Configuration

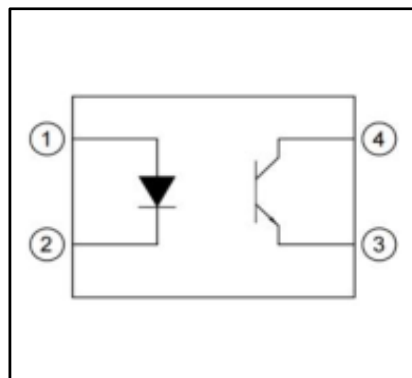

Pin Configuration
1. Anode
2. Cathode
3. Emitter
4. Collector

Product Nomenclature

WOC -10XX - XX - XX - XX
 ① ② ③ ④ ⑤

Designation:

WOC =WAYON Optocoupler

10XX= Product Series(100X,101X)

- ① = Tape and Reel option (1)
- ② = Lead frame Material (2)
- ③ = VDE order option(fixed code "V")
- ④ = Halogen free option(fixed code"G")
- ⑤ = Custmer code

Notes

1. Tape and Reel option:

Symbol	Description
TP&TP1	Tape and Reel Type

2. Lead frame Material

Symbol	Description
NONE	Copper

Marking Information



Designation:

WAYON: denotes WAYON

10XX : denotes Device

1Y : denotes year code

WW: denotes week code

Maximum Ratings

Parameter		Symbol	Value	Unit
Input	Forward Current	I_F	50	mA
	Reverse Voltage	V_R	6	V
	Power Dissipation	P	70	mW
	Peak Forward Current (100 μ s pulse, 100Hz)	I_{FP}	1	A
	Thermal Resistance Junction-Ambient	R_{thJ-A}	325	$^{\circ}C/W$
	Thermal Resistance Junction-Case	R_{thJ-C}	200	$^{\circ}C/W$
Output	Collector - Emitter Voltage	V_{CEO}	80	V
	Emitter - Collector Voltage	V_{ECO}	7	V
	Collector Current	I_C	50	mA
	Collector Power Dissipation	P_C	150	mW
Operating temperature range		T_{op}	-55 ~ 110	$^{\circ}C$
Storage temperature range		T_{stg}	-55 ~ 125	$^{\circ}C$
Total Power consumption		P(W)	200	mW
Isolation Voltage ⁽¹⁾		V_{ISO}	5000	V _{rms}
Soldering Temperature ⁽²⁾		T_{SOL}	260	$^{\circ}C$

Notes:

(1). AC for 1 minute, R.H.= 40 ~ 60% R.H. In this test, pins 1, 2 are shorted together, and pins 3, 4 are shorted together.

(2). For 10 seconds

Electrical Optical Characteristics (TA=25°C)

Parameter		Symbol	Conditions	Min.	Typ.	Max.	Unit
Input	Forward Voltage	V_F	$I_F = 20\text{mA}$	-	1.2	1.4	V
	Reverse Current	I_R	$V_R = 4\text{V}$	-	-	10	μA
	Terminal Capacitance	C_t	$V = 0, f = 1\text{KHz}$	-	30	250	pF
Output	Collector Dark Current	I_{CEO}	$V_{CE} = 20\text{V}, I_F = 0$	-	-	100	nA
	Collector-Emitter Breakdown Voltage	BV_{CEO}	$I_C = 0.1\text{mA}, I_F = 0$	80			V
	Emitter-Collector Breakdown Voltage	BV_{ECO}	$I_E = 10\mu\text{A}, I_F = 0$	7			V
Collector-Emitter Saturation Voltage		$V_{CE(sat)}$	$I_F = 10\text{mA}, I_C = 1\text{mA}$			0.3	V
Isolation Resistance		R_{ISO}	DC500V, 40~60% R.H.	5×10^{10}	1×10^{11}	-	Ω
Floating Capacitance		C_f	$V = 0, f = 1\text{MHz}$		0.6	1	pF
Response Time (Rise)		t_r	$V_{CE} = 5\text{V}, I_C = 5\text{mA}, R_L = 100\Omega$			18	μs
Response Time (Fall)		t_r				18	μs

Rank Table Of Current Transfer Ratio (CTR=IC/IF x 100%)

Rank Code	Symbol	Min	Max	Conditon
HT-1010,1000	CTR	50	600	$I_F = 5\text{mA}, V_{CE} = 5\text{V}, T_a = 25^\circ\text{C}$
HT-1017,1007		80	160	
HT-1018,1008		130	260	
HT-1019,1009		200	400	
HT-1012,1002	CTR	63	125	$I_F = 10\text{mA}, V_{CE} = 5\text{V}, T_a = 25^\circ\text{C}$
HT-1013,1003		100	200	
HT-1014,1004		160	320	
HT-1012,1002	CTR	22		$I_F = 1\text{mA}, V_{CE} = 5\text{V}, T_a = 25^\circ\text{C}$
HT-1013,1003		34		
HT-1014,1004		56		

Characteristics Curves

Fig.1 Relative Current Transfer Ratio vs. Forward Current

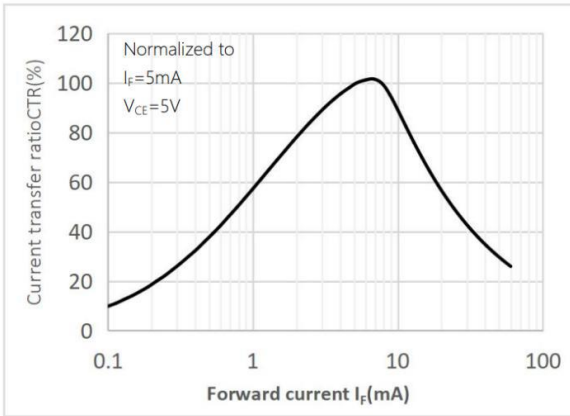

Fig.2 Forward Current vs. Forward Voltage

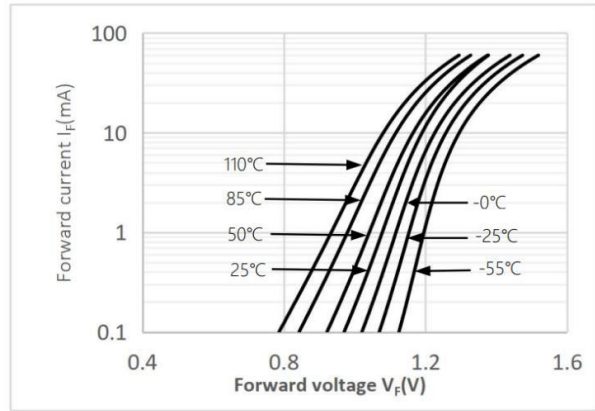

Fig.3 Collector Current vs. Collector-emitter Voltage

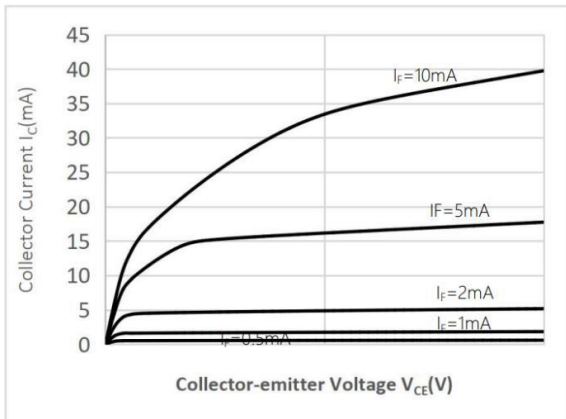

Fig.4 Relative Current Transfer Ratio vs. Ambient Temperature

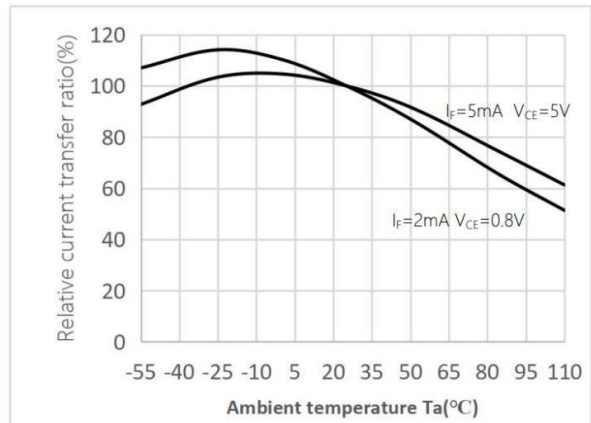

Fig.5 Collector-emitter Saturation Voltage vs. Ambient Temperature

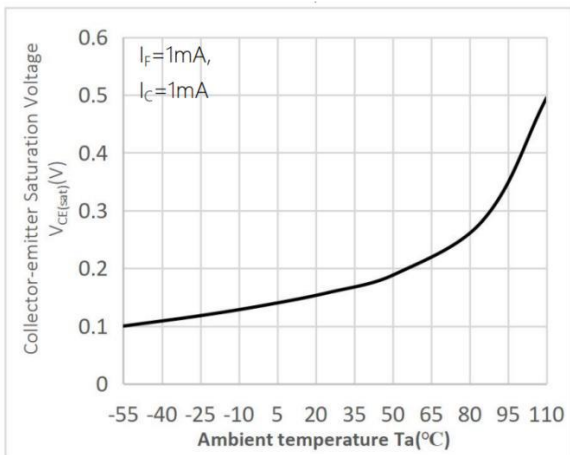

Fig.6 Collector Dark Current vs Ambient Temperature

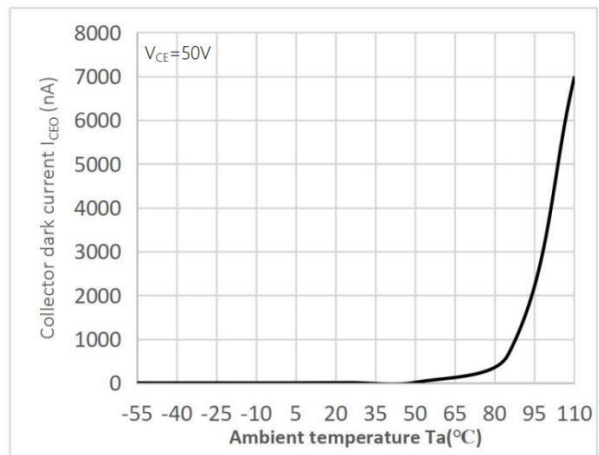

Fig.7 Response Time vs. Load Resistance

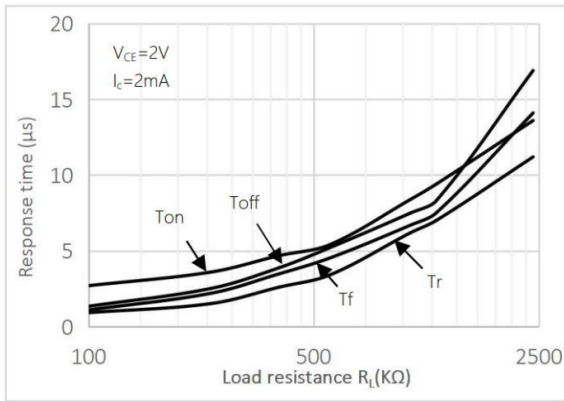

Fig.8 Frequency Response

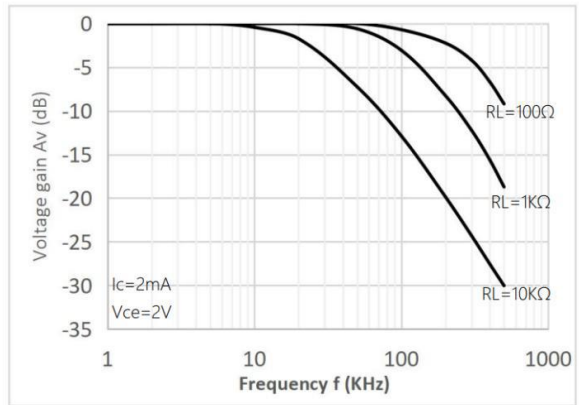

Fig.9 Collector-emitter Saturation Voltage vs Forward Current

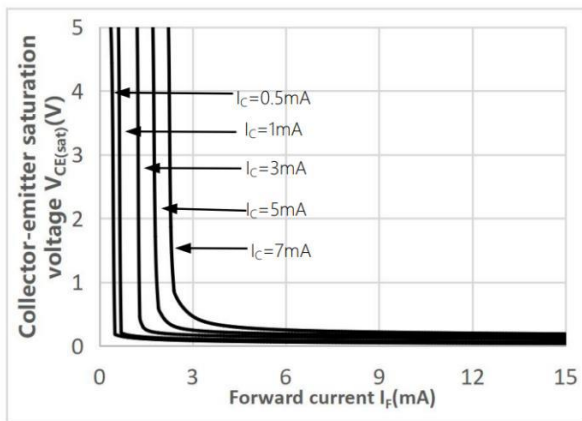
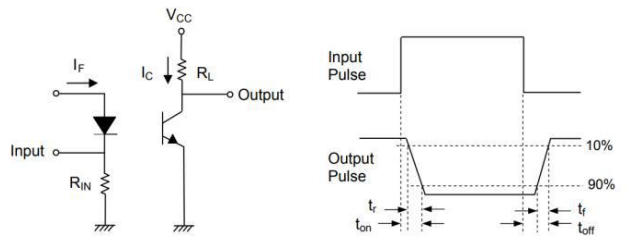
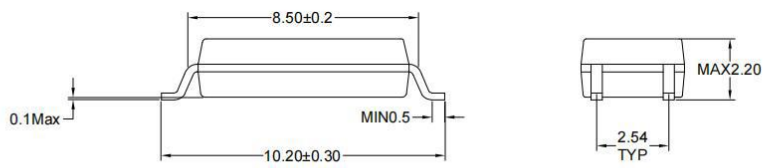
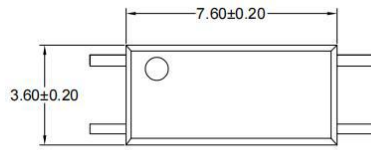

Fig.10 Switching Time Test Circuit & Waveform



Outline Dimensions



Unit: mm

Tolerance: $\pm 0.1 \text{ mm}$

Recommended solder pad Design

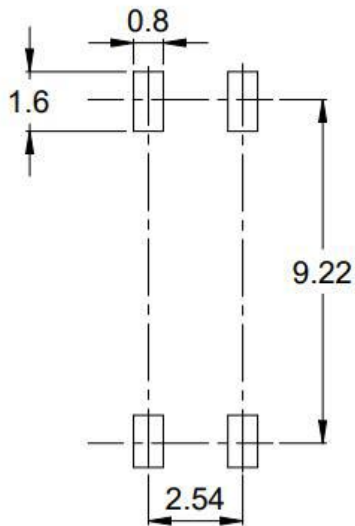

Unit: mm

Tolerance: $\pm 0.1 \text{ mm}$

Temperature Profile Of Soldering

1. IR Reflow soldering(JEDEC-STD-020D compliant)

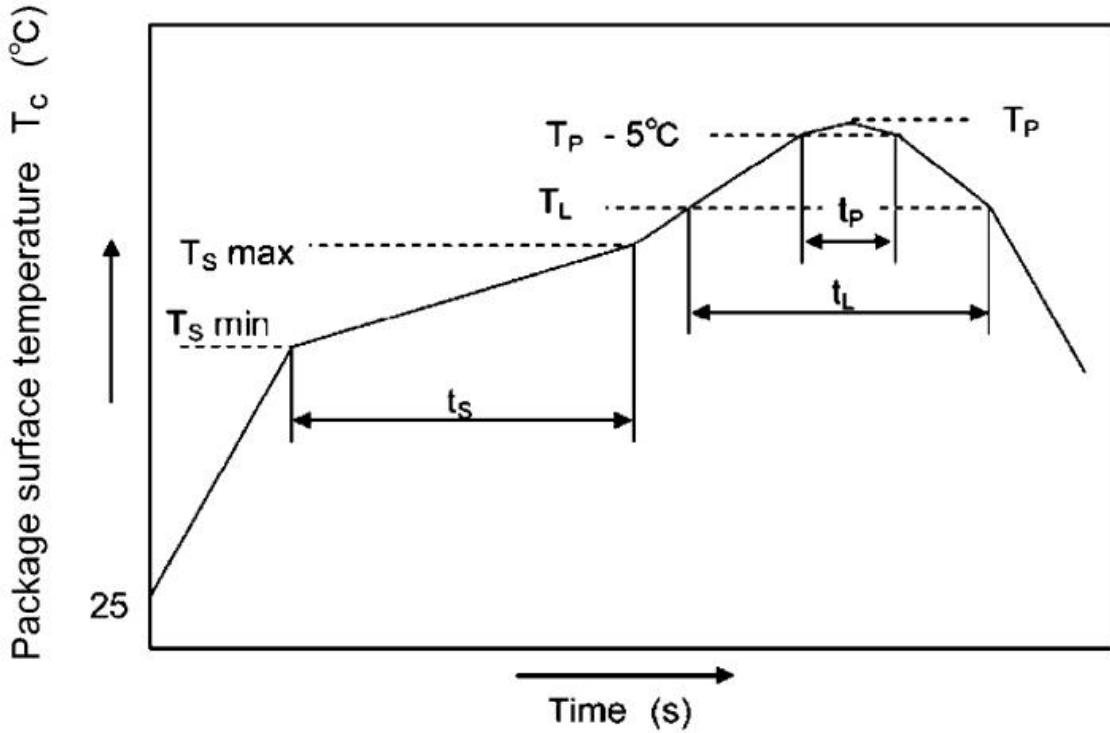

Item	Symbol	Min.	Max.	Unit
Preheat Temperature	T_s	150	200	°C
Preheat Time	t_s	60	120	s
Ramp-Up Rate (T_L to T_P)	-	-	3	°C/s
Liquidus Temperature	T_L	217		°C
Time Above T_L	t_L	60	150	s
Peak Temperature	T_P	-	260	°C
Time During Which T_c Is Between (T_P-5) and T_P	t_p	-	30	s
Ramp-down Rate(T_P to T_L)	-	3	6	°C/s

Note:

One time soldering reflow is recommended within the condition of temperature and time profile shown below. Do not solder more than three times.

2. Wave Soldering(JEDEC22A111 compliant)

One time soldering is recommended within the condition.

Temperature: $260 \pm 0/-5^{\circ}\text{C}$.

Time: 10 sec.

Preheat temperature: 25 to 140°C .

Preheat time: 30 to 80 sec.

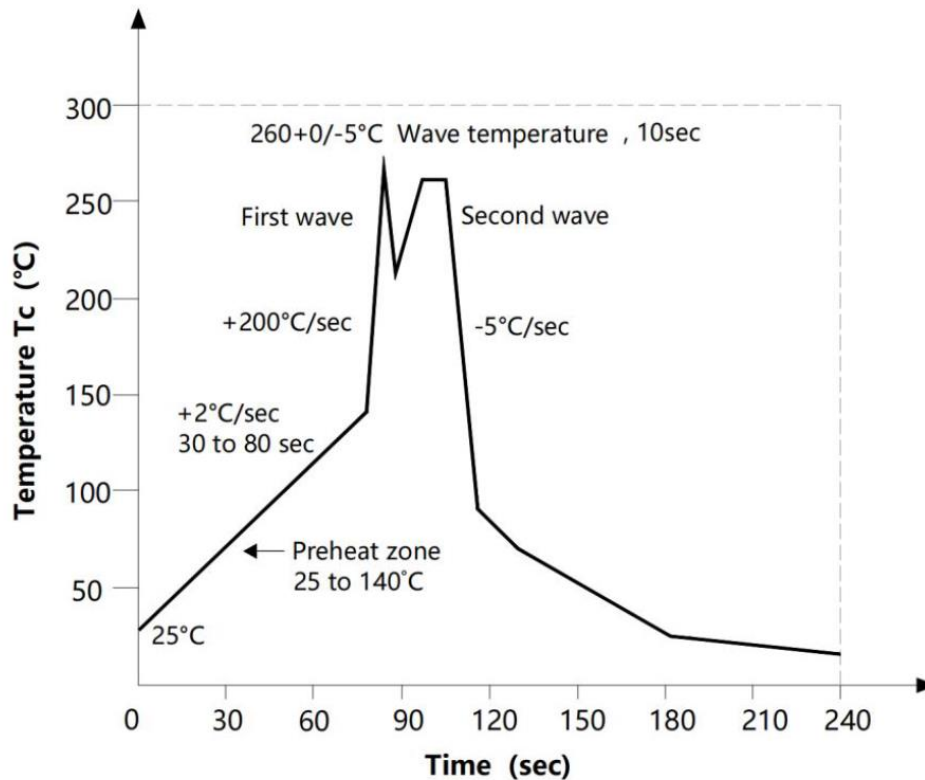

3. Hand soldering by soldering iron

Allow single lead soldering in every single process. One time soldering is recommended.

Temperature: $380 \pm 0/-5^{\circ}\text{C}$

Time: 3 sec max

Packing

Tape and Reel

Option TP:

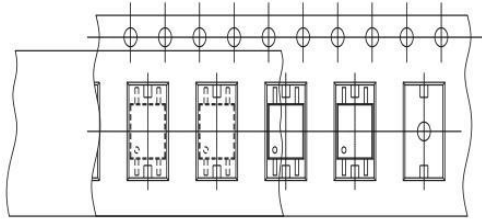

Option TP1:

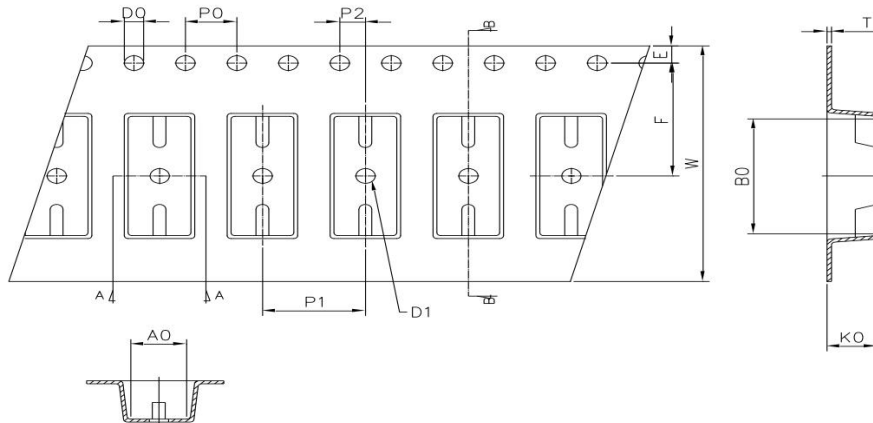
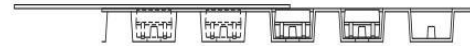
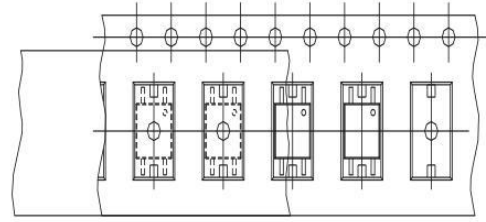

Deminsion/mm	W	E	F	P0	P1	P2
Packagetype:S	16±0.2	1.75±0.1	7.5±0.1	4±0.1	8±0.1	2±0.1

Deminsion/mm	A0	B0	D0	D1	K0	T
Packagetype:S	3.95±0.1	10.82±0.1	1.5±0.1	1.5±0.1	2.25±0.1	0.4±0.1

Packagetype:S	Reel	Inner carton	Outer carton
QTY/PCS	3K/reel	6K(2 reels)	60K

CONTACT INFORMATION

No.1001, Shiwan (7) Road, Pudong District, Shanghai, P.R.China.201207

Tel: 86-21-68969993 Fax: 86-21-50757680 Email: market@way-on.com

WAYON website: <http://www.way-on.com>

For additional information, please contact your local Sales Representative.

WAYON ® is registered trademark of WAYON Corporation.

Product Specification Statement

1. The product specification aims to provide users with a reference regarding various product parameters, performance, and usage. It presents certain aspects of the product's performance in graphical form and is intended solely for users to select product and make product comparisons, enabling users to better understand and evaluate the characteristics and advantages of the product. It does not constitute any commitment, warranty, or guarantee.
2. The product parameters described in the product specification are numerical values, characteristics, and functions obtained through actual testing or theoretical calculations of the product in an independent or ideal state. Due to the complexity of product applications and variations in test conditions and equipment, there may be slight fluctuations in parameter test values. WAYON shall not guarantee that the actual performance of the product when installed in the customer's system or equipment will be entirely consistent with the product specification, especially concerning dynamic parameters. It is recommended that users consult with professionals for product selection and system design. Users should also thoroughly validate and assess whether the actual parameters and performance when installed in their respective systems or equipment meet their requirements or expectations. Additionally, users should exercise caution in verifying product compatibility issues, and WAYON assumes no responsibility for the application of the product.
3. WAYON strives to provide accurate and up-to-date information to the best of our ability. However, due to technical, human, or other reasons, WAYON cannot guarantee that the information provided in the product specification is entirely accurate and error-free. WAYON shall not be held responsible for any losses or damages resulting from the use or reliance on any information in these product specifications. WAYON reserves the right to revise or update the product specification and the products at any time without prior notice, and the user's continued use of the product specification is considered an acceptance of these revisions and updates. Prior to purchasing and using the product, users should verify the above information with WAYON to ensure that the product specification is the most current, effective, and complete. If users are particularly concerned about product parameters, please consult WAYON in detail or request relevant product test reports. Any data not explicitly mentioned in the product specification shall be subject to separate agreement.
4. Users are advised to pay attention to the parameter limit values specified in the product specification and maintain a certain margin in design or application to ensure that the product does not exceed the parameter limit values defined in the product specification. This precaution should be taken to avoid exceeding one or more of the limit values, which may result in permanent irreversible damage to the product, ultimately affecting the quality and reliability of the system or equipment.
5. The design of the product is intended to meet civilian needs and is not guaranteed for use in harsh environments or precision equipment. It is not recommended for use in systems or equipment such as medical devices, aircraft, nuclear power, and similar systems, where failures in these systems or equipment could reasonably be expected to result in personal injury. WAYON shall assume no responsibility for any consequences resulting from such usage.
6. Users should also comply with relevant laws, regulations, policies, and standards when using the product specification. Users are responsible for the risks and liabilities arising from the use of the product specification and must ensure that it is not used for illegal purposes. Additionally, users should respect the intellectual property rights related to the product specification and refrain from infringing upon any third-party legal rights. WAYON shall assume no responsibility for any disputes or controversies arising from the above-mentioned issues in any form.