

## 100V N-Channel Enhancement Mode Power MOSFET

### Description

WMO30N10TSH uses advanced power trench technology that has been especially tailored to minimize the on-state resistance and yet maintain superior switching performance.

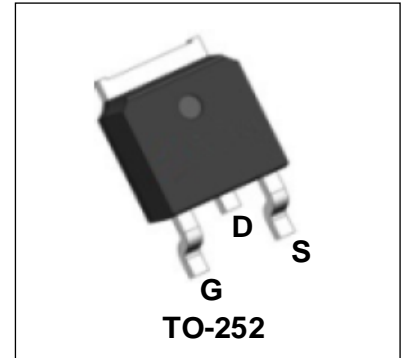

### Features

- $V_{DS} = 100V$ ,  $I_D = 30A$   
 $R_{DS(on)} < 38m\Omega$  @  $V_{GS} = 10V$
- Green Device Available
- 100% EAS Guaranteed
- RoHS Compliant & Halogen-Free
- Optimized for High Speed Smooth Switching



**RoHS**  
compliant

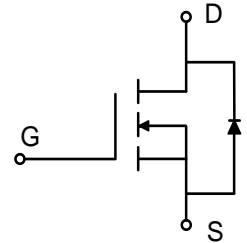

### Applications

- Synchronous Rectification
- DC/DC Converter

### Absolute Maximum Ratings (T<sub>A</sub> = 25°C, unless otherwise noted)

Parameter		Symbol	Value	Unit
Drain-Source Voltage		$V_{DS}$	100	V
Gate-Source Voltage		$V_{GS}$	±20	V
Continuous Drain Current	T <sub>C</sub> =25°C	$I_D$	30	A
	T <sub>C</sub> =100°C		19	
Pulsed Drain Current <sup>1</sup>		$I_{DM}$	120	A
Single Pulse Avalanche Energy <sup>2</sup>		<b>EAS</b>	64.8	mJ
Total Power Dissipation	T <sub>C</sub> =25°C	$P_D$	62.5	W
Operating Junction and Storage Temperature Range		$T_J$ , $T_{STG}$	-55 to 150	°C

### Thermal Characteristics

Parameter	Symbol	Value	Unit
Thermal Resistance from Junction-to-Ambient <sup>3</sup>	$R_{\theta JA}$	50	°C/W
Thermal Resistance from Junction-to-Case	$R_{\theta JC}$	2	°C/W

**Electrical Characteristics** ( $T_J = 25^\circ\text{C}$ , unless otherwise noted)

Parameter	Symbol	Test Conditions	Min.	Typ.	Max.	Unit	
<b>Static Characteristics</b>							
Drain-Source Breakdown Voltage	$V_{(BR)DSS}$	$V_{GS} = 0V, I_D = 250\mu A$	100	-	-	V	
Gate-Body Leakage Current	$I_{GSS}$	$V_{DS} = 0V, V_{GS} = \pm 20V$	-	-	$\pm 100$	nA	
Zero Gate Voltage Drain Current	$T_J=25^\circ\text{C}$	$I_{DSS}$	$V_{DS} = 100V, V_{GS} = 0V$	-	-	1	$\mu A$
	$T_J=100^\circ\text{C}$			-	-	100	
Gate-Threshold Voltage	$V_{GS(th)}$	$V_{DS} = V_{GS}, I_D = 250\mu A$	2.5	3	3.5	V	
Drain-Source on-Resistance <sup>4</sup>	$R_{DS(on)}$	$V_{GS} = 10V, I_D = 20A$	-	30	38	m $\Omega$	
Forward Transconductance <sup>4</sup>	$g_{fs}$	$V_{DS} = 10V, I_D = 20A$	-	110	-	S	
<b>Dynamic Characteristics<sup>5</sup></b>							
Input Capacitance	$C_{iss}$	$V_{DS} = 50V, V_{GS} = 0V,$ $f = 1\text{MHz}$	-	2990	-	$\mu F$	
Output Capacitance	$C_{oss}$		-	83	-		
Reverse Transfer Capacitance	$C_{rss}$		-	58.5	-		
Gate Resistance	$R_G$	$f = 1\text{MHz}$	-	2.2	-	$\Omega$	
<b>Switching Characteristics<sup>5</sup></b>							
Total Gate Charge	$Q_g$	$V_{GS} = 10V, V_{DS} = 50V,$ $I_D = 20A$	-	47	-	nC	
Gate-Source Charge	$Q_{gs}$		-	13.2	-		
Gate-Drain Charge	$Q_{gd}$		-	9.1	-		
Turn-on Delay Time	$t_{d(on)}$	$V_{GS} = 10V, V_{DD} = 50V,$ $R_G = 3\Omega, I_D = 20A$	-	13.2	-	ns	
Rise Time	$t_r$		-	9.2	-		
Turn-off Delay Time	$t_{d(off)}$		-	32	-		
Fall Time	$t_f$		-	7.6	-		
Body Diode Reverse Recovery Time	$t_{rr}$	$I_F = 20A, di/dt = 100A/\mu s$	-	33	-	ns	
Body Diode Reverse Recovery Charge	$Q_{rr}$		-	36.5	-	nC	
<b>Drain-Source Body Diode Characteristics</b>							
Diode Forward Voltage <sup>4</sup>	$V_{SD}$	$I_S = 20A, V_{GS} = 0V$	-	-	1.2	V	
Continuous Source Current	$T_C=25^\circ\text{C}$	$I_S$	-	-	30	A	

## Notes:

1. Repetitive rating, pulse width limited by junction temperature  $T_{J(MAX)}=150^\circ\text{C}$ .
2. The test condition is  $V_{DD}=25V, V_{GS}=10V, L=0.4\text{mH}, I_{AS}=18A$ .
3. The data tested by surface mounted on a 1 inch2 FR-4 board with 2OZ copper, The value in any given application depends on the user's specific board design.
4. The data tested by pulsed, pulse width  $\leq 300\mu s$ , duty cycle  $\leq 2\%$ .
5. This value is guaranteed by design hence it is not included in the production test.

Typical Characteristics

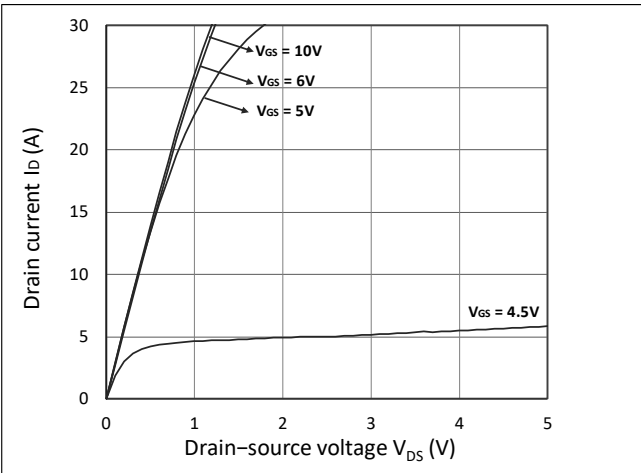

Figure 1. Output Characteristics

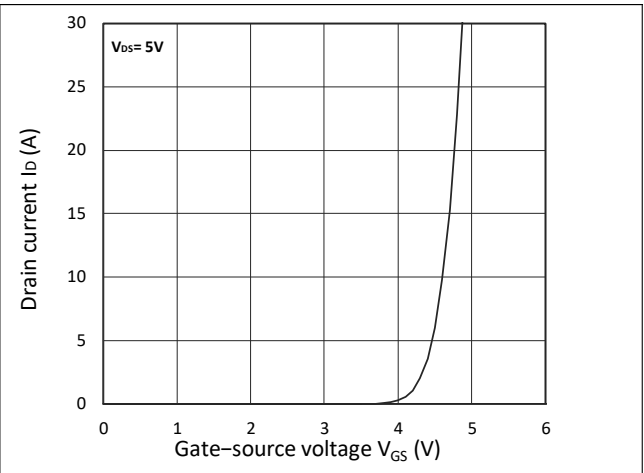

Figure 2. Transfer Characteristics

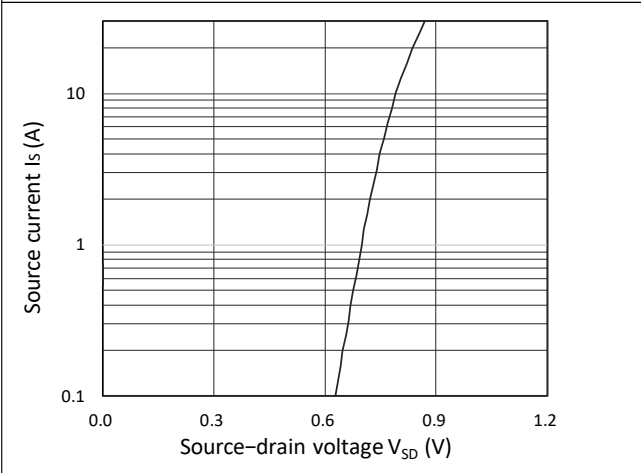

Figure 3. Forward Characteristics of Reverse

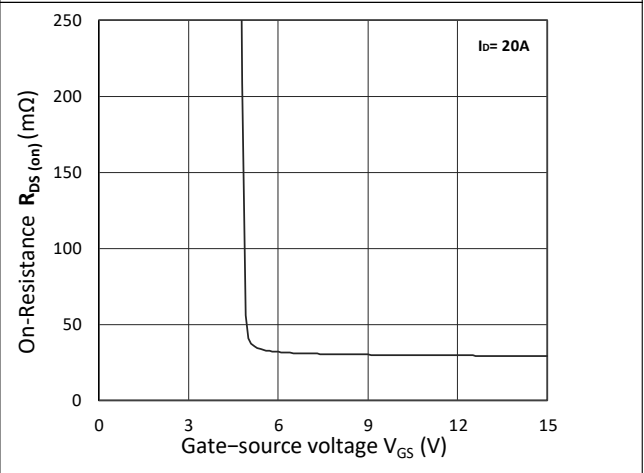

Figure 4.  $R_{DS(ON)}$  vs.  $V_{GS}$

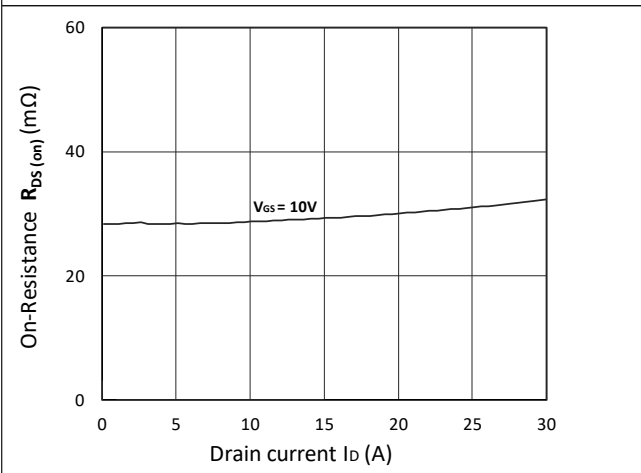

Figure 5.  $R_{DS(ON)}$  vs.  $I_D$

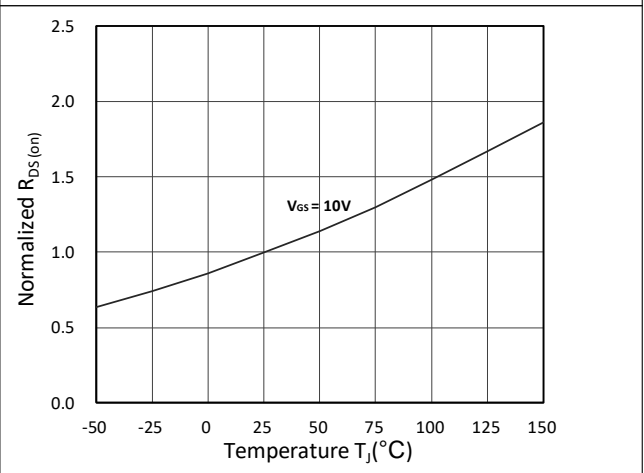

Figure 6. Normalized  $R_{DS(on)}$  vs. Temperature

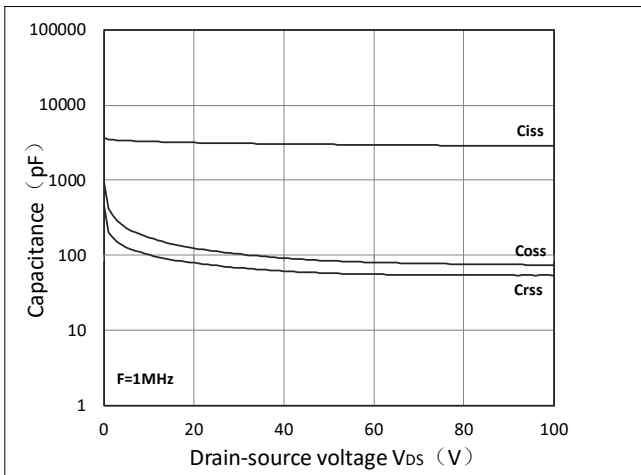

Figure 7. Capacitance Characteristics

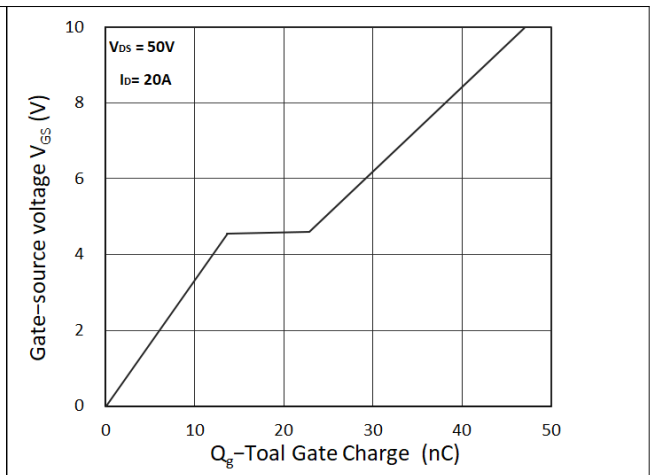

Figure 8. Gate Charge Characteristics

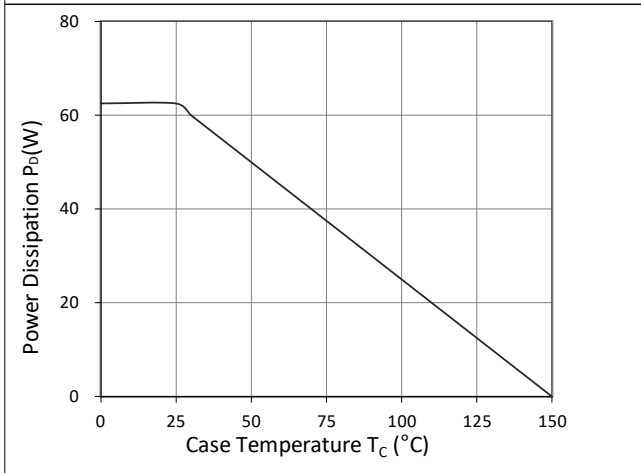

Figure 9. Power Dissipation

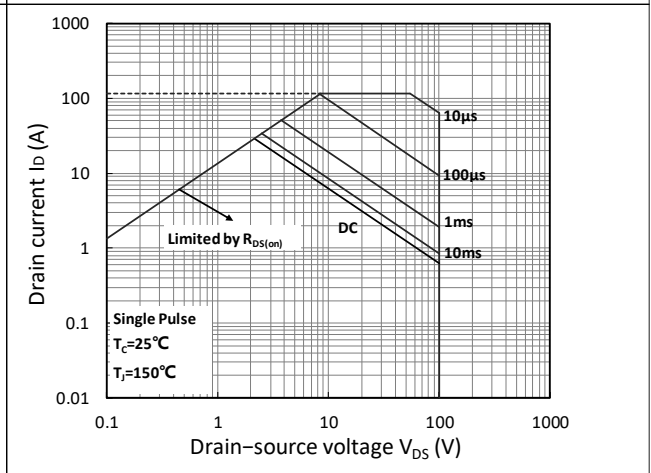

Figure 10. Safe Operating Area

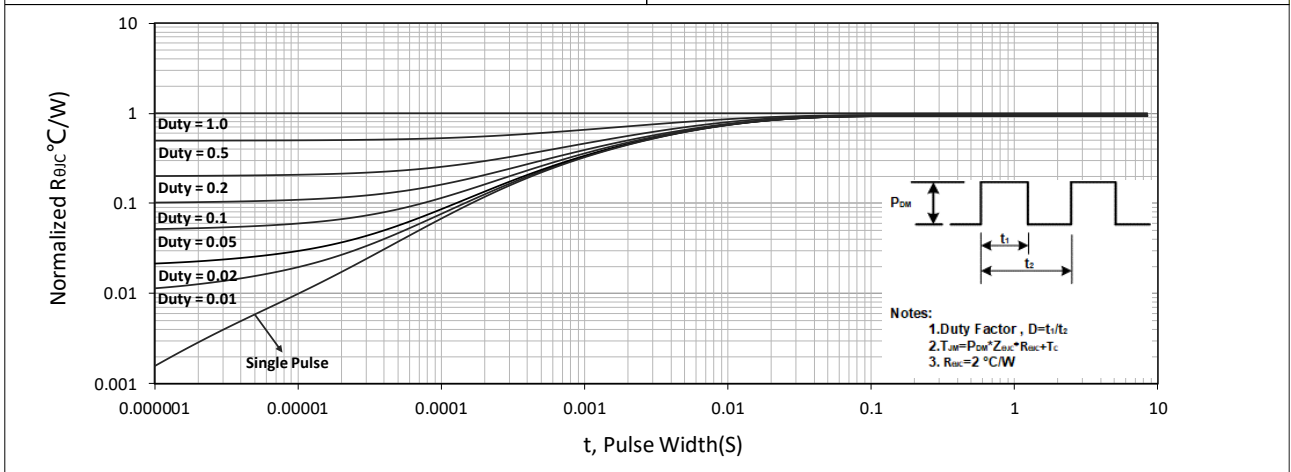

Figure 11. Normalized Maximum Transient Thermal Impedance

Test Circuit

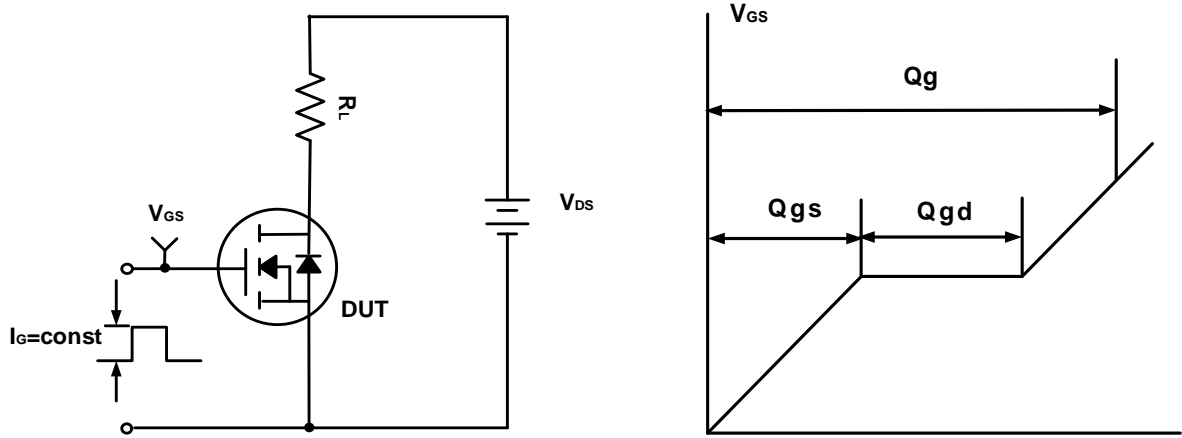

Figure A. Gate Charge Test Circuit & Waveforms

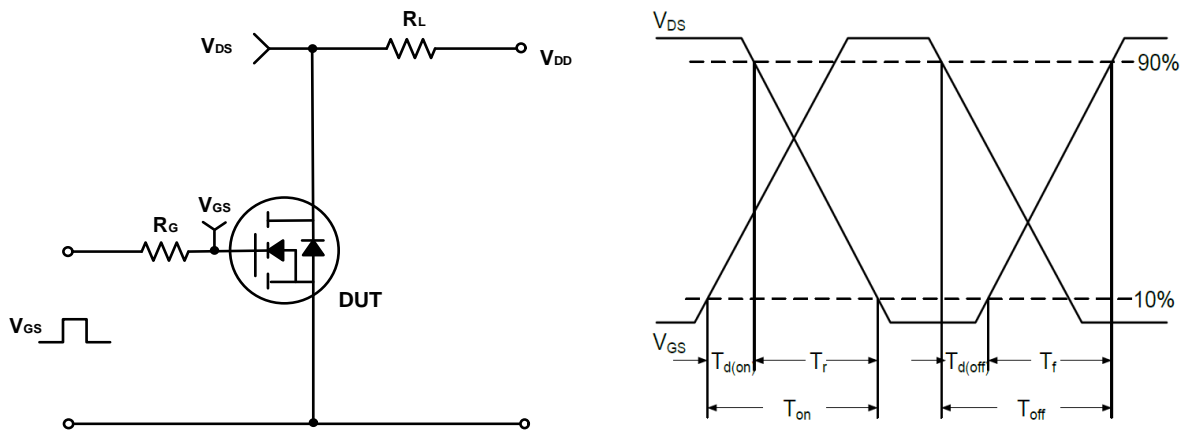

Figure B. Switching Test Circuit & Waveforms

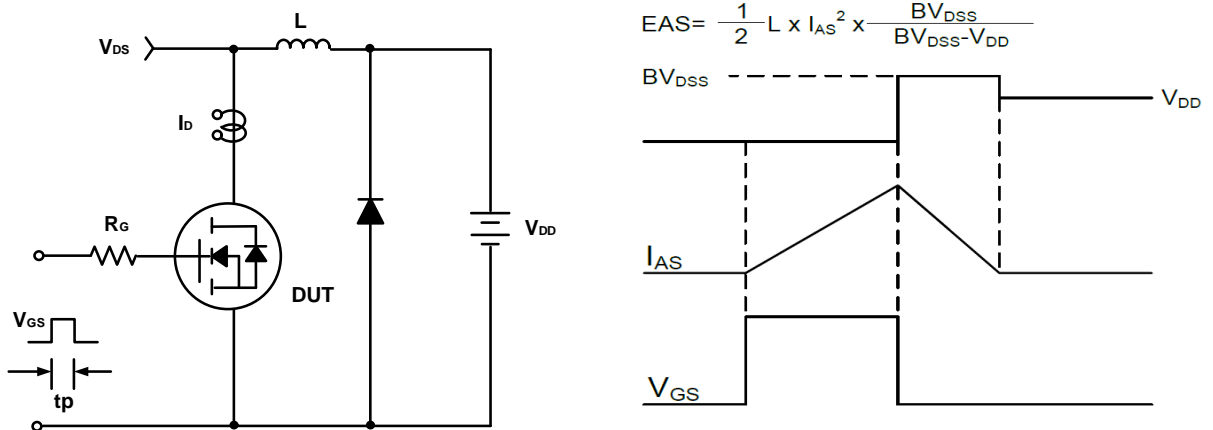
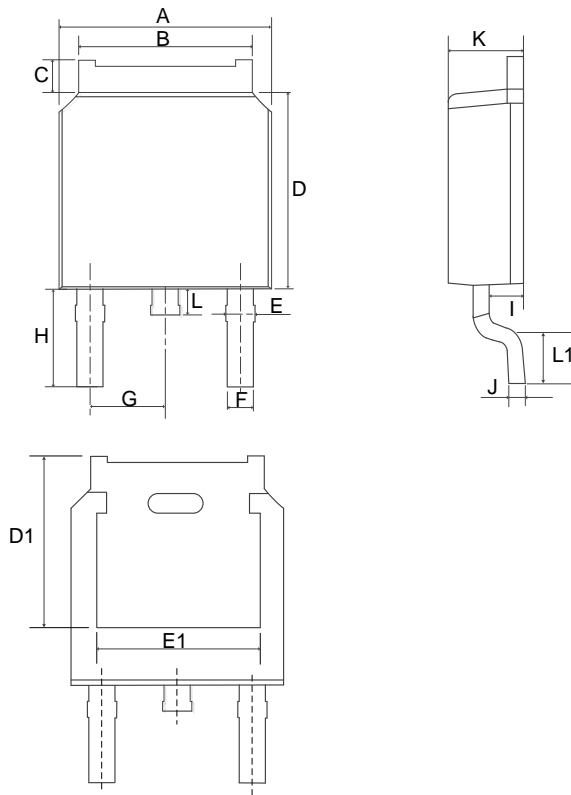

Figure C. Unclamped Inductive Switching Circuit & Waveforms

## Mechanical Dimensions for TO-252

## COMMON DIMENSIONS



SYMBOL	MM	
	MIN	MAX
A	6.40	6.80
B	5.13	5.50
C	0.88	1.28
D	5.90	6.22
D1	5.35REF	
E	0.68	1.10
E1	4.83REF	
F	0.68	0.91
G	2.29REF	
H	2.90REF	
I	0.85	1.17
J	0.51REF	
K	2.10	2.50
L	0.40	1.00
L1	1.50REF	

## Ordering Information

Part	Package	Marking	Packing method
WMO30N10TSH	TO-252	WMO30N10TSH	Tape and Reel

## Marking Information

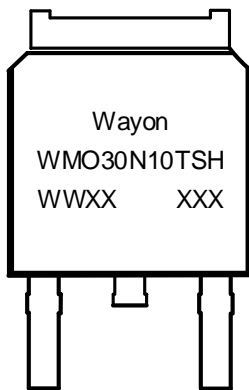

WMO30N10TSH = Device code

WWXX XXX= Date code

## Contact Information

No.1001, Shiwan(7) Road, Pudong District, Shanghai, P.R.China.201207

Tel: 86-21-50310888 Fax: 86-21-50757680 Email: market@way-on.com

WAYON website: <http://www.way-on.com>

For additional information, please contact your local Sales Representative.

 is registered trademarks of Wayon Corporation.

## Product Specification Statement

1. The product specification aims to provide users with a reference regarding various product parameters, performance, and usage. It presents certain aspects of the product's performance in graphical form and is intended solely for users to select product and make product comparisons, enabling users to better understand and evaluate the characteristics and advantages of the product. It does not constitute any commitment, warranty, or guarantee.
2. The product parameters described in the product specification are numerical values, characteristics, and functions obtained through actual testing or theoretical calculations of the product in an independent or ideal state. Due to the complexity of product applications and variations in test conditions and equipment, there may be slight fluctuations in parameter test values. WAYON shall not guarantee that the actual performance of the product when installed in the customer's system or equipment will be entirely consistent with the product specification, especially concerning dynamic parameters. It is recommended that users consult with professionals for product selection and system design. Users should also thoroughly validate and assess whether the actual parameters and performance when installed in their respective systems or equipment meet their requirements or expectations. Additionally, users should exercise caution in verifying product compatibility issues, and WAYON assumes no responsibility for the application of the product.
3. WAYON strives to provide accurate and up-to-date information to the best of our ability. However, due to technical, human, or other reasons, WAYON cannot guarantee that the information provided in the product specification is entirely accurate and error-free. WAYON shall not be held responsible for any losses or damages resulting from the use or reliance on any information in these product specifications. WAYON reserves the right to revise or update the product specification and the products at any time without prior notice, and the user's continued use of the product specification is considered an acceptance of these revisions and updates. Prior to purchasing and using the product, users should verify the above information with WAYON to ensure that the product specification is the most current, effective, and complete. If users are particularly concerned about product parameters, please consult WAYON in detail or request relevant product test reports. Any data not explicitly mentioned in the product specification shall be subject to separate agreement.
4. Users are advised to pay attention to the parameter limit values specified in the product specification and maintain a certain margin in design or application to ensure that the product does not exceed the parameter limit values defined in the product specification. This precaution should be taken to avoid exceeding one or more of the limit values, which may result in permanent irreversible damage to the product, ultimately affecting the quality and reliability of the system or equipment.
5. The design of the product is intended to meet civilian needs and is not guaranteed for use in harsh environments or precision equipment. It is not recommended for use in systems or equipment such as medical devices, aircraft, nuclear power, and similar systems, where failures in these systems or equipment could reasonably be expected to result in personal injury. WAYON shall assume no responsibility for any consequences resulting from such usage.
6. Users should also comply with relevant laws, regulations, policies, and standards when using the product specification. Users are responsible for the risks and liabilities arising from the use of the product specification and must ensure that it is not used for illegal purposes. Additionally, users should respect the intellectual property rights related to the product specification and refrain from infringing upon any third-party legal rights. WAYON shall assume no responsibility for any disputes or controversies arising from the above-mentioned issues in any form.