

Silicon Controlled Rectifier

Features

- Blocking Voltage to 800V
- Glass Passivated Surface for Reliability and Uniformity
- RoHS Compliant
- High Dv/Dt Rate
- $I_{T(RMS)}$ to 4A of Triacs

Pin Configuration

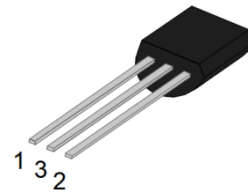
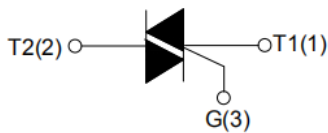

TO-92

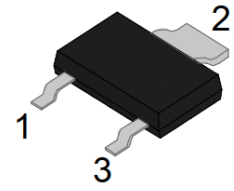

SOT-223-2L

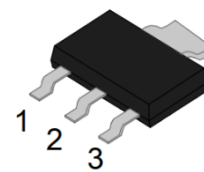

SOT-223-3L

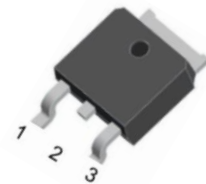

TO-252-4R

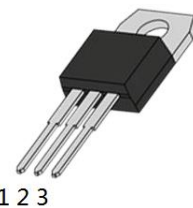

TO-220B(No-Ins)

Absolute Maximum Ratings (T_c=25°C Unless otherwise specified)

Parameter	Symbol	Value	Unit
Storage junction temperature range	T _{stg}	-40~150	°C
Operating junction temperature range	T _j	-40~125	°C
Repetitive peak off-state voltage (T _j =25°C)	V _{DRM}	800	V
Repetitive peak reverse voltage (T _j =25°C)	V _{RPM}	800	V
RMS on-state current	I _{T(RMS)}	4	A
Non repetitive surge peak on-state current (full cycle, F=50Hz)	I _{TSM}	25	A

I ² t value for fusing (tp=10ms)	I ² t	3.1	A ² s
Critical rate of rise of on-state current (IG=2xIGT)	di/dt	50	A/μs
Peak gate current	I _{GM}	2	A
Average gate power dissipation	P _{G(AV)}	0.5	W
Peak gate power	P _{GM}	5	W
Thermal Resistance(between Junction and Case) @TO-92	R _{θ(J-C)}	11.3 (Typ.)	°C/W
Thermal Resistance(between Junction and Case) @SOT-223-2L/SOT-223-3L	R _{θ(J-C)}	3.9 (Typ.)	°C/W
Thermal Resistance(between Junction and Case) @TO-252-4R	R _{θ(J-C)}	3.8 (Typ.)	°C/W
Thermal Resistance(between Junction and Case) @TO-220B(No-Ins)	R _{θ(J-C)}	3.2 (Typ.)	°C/W

Electronics Characteristics (T_c=25°C Unless otherwise specified)

Parameter	Symbol	Quadrant		Value		Unit
				T	D	
Gate Trigger Current (Continuous dc) @VD=12V, RL=33Ω	I _{GT}	I - II - III	MAX	5	5	mA
		IV		5	10	mA
Gate Trigger Voltage (Continuous dc) @VD=12V, RL=33Ω	V _{GT}	ALL		1.3		V
Gate non-trigger voltage@VD=V _{DRM}	V _{GD}	ALL	MIN	0.2		V
Holding Current@IT=100mA	I _H	-	MAX	5	10	mA
Latching Current@IG=1.2IGT	I _L	I - III-IV	MAX	8	10	mA
		II		12	15	

Critical Rate-of-Rise of Off State Voltage @VD=0.66×VDRM, Tj=125°C, Gate Open	dV/dt	-	MIN	10	20	V/μs
Peak Forward On-State Voltage @ITM=5A, tp=380μs, Tj=25°C	V _{TM}	-	MAX	1.7		V
Peak Repetitive Forward @VDRM=VRRM, Tj=25°C	I _{DRM}	-	MAX	5		μA
Reverse Blocking Current @VDRM=VRRM, Tj=125°C	I _{RDM}	-	MAX	0.5		mA

Note: The above typical parameters or typical characteristics are only indicative and do not make specific guarantees. If detailed values are required, additional communication and provision are required.

FIG.1: Maximum power dissipation versus RMS on-state current

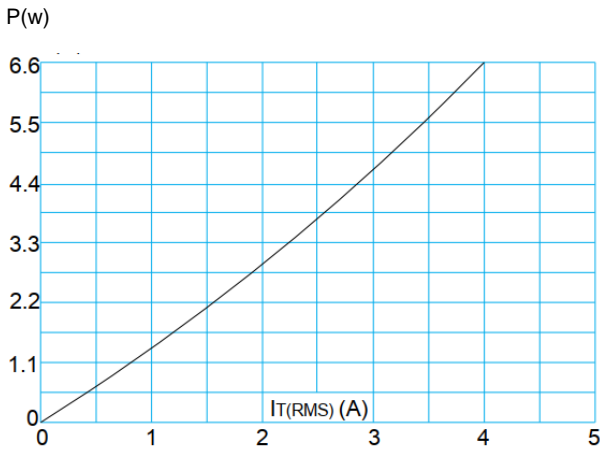

FIG.3: Surge peak on-state current versus number of cycles

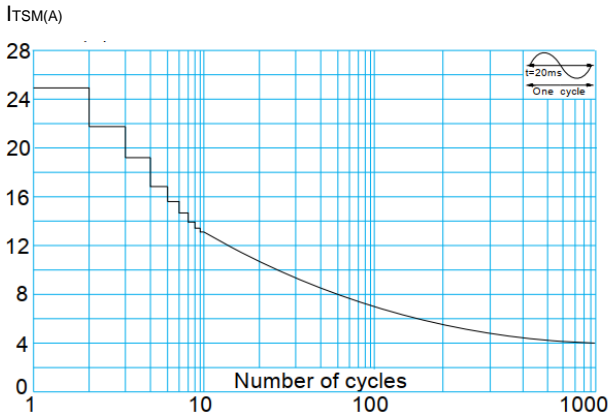

FIG.5: Non-repetitive surge peak on-state current for a sinusoidal pulse with width $t_p < 20\text{ms}$, and corresponding value of $I^2 t$ (I - II-III: $dI/dt < 50\text{A}/\mu\text{s}$; IV: $dI/dt < 10\text{A}/\mu\text{s}$)

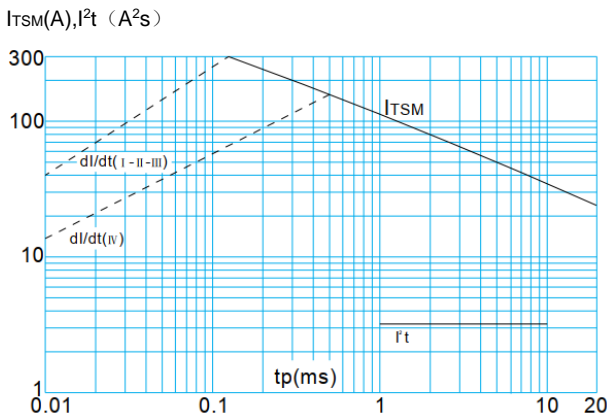

FIG.2: RMS on-state current versus case temperature in different packaging

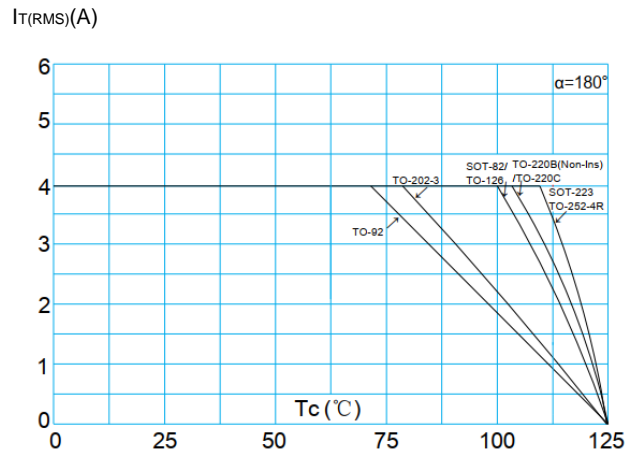

FIG.4: On-state characteristics (maximum values)

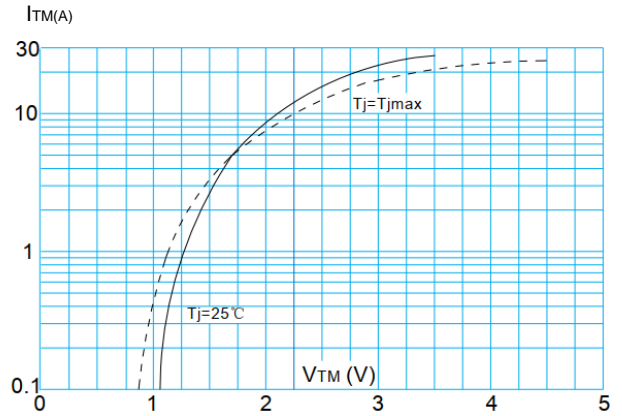

FIG.6: Relative variations of gate trigger current versus junction temperature

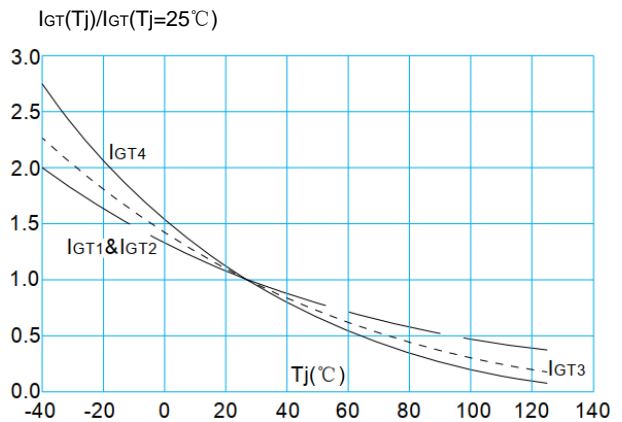
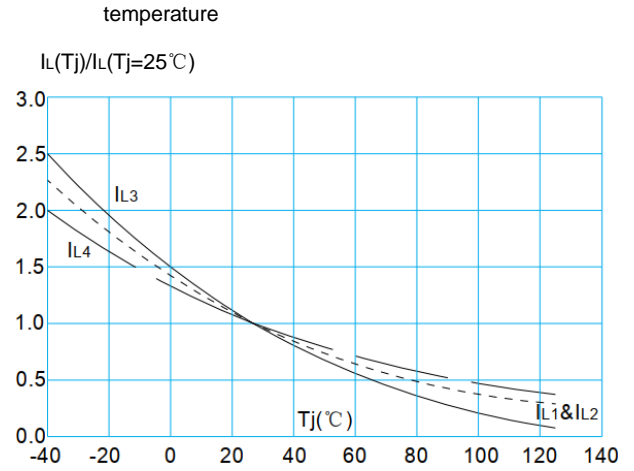
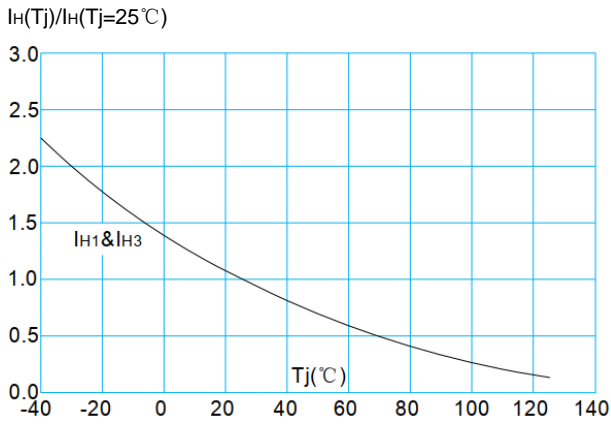
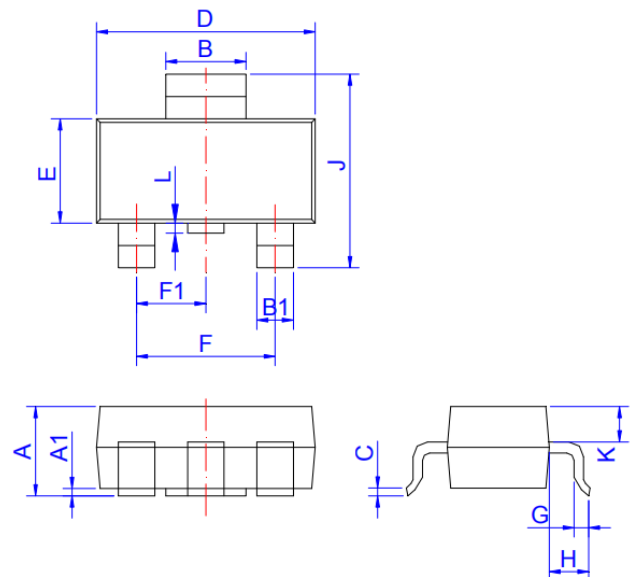

FIG. 7: Relative variations of holding current versus junction temperature FIG. 8: Relative variations of latching current versus junction temperature



Outline Drawing- SOT-223-2L

SYMBOL	MM		
	MIN	NOM	MAX
A	1.5	1.6	1.8
A1	0.01	0.06	0.10
B	2.9	3.0	3.1
B1	0.6	0.7	0.84
C	0.22	0.26	0.35
D	6.3	6.5	6.95
E	3.3	3.5	3.7
F	-	4.6	-
F1	-	2.3	-
G	0.7	0.9	1.1
H	1.5	1.75	2
J	6.7	7.0	7.3
K	-	0.9	-
L	0	0.1	0.2



Outline Drawing- SOT-223-3L

SYMBOL	MM		
	MIN	NOM	MAX
A	1.5	1.6	1.81
A1	0.01	0.06	0.14
B	2.9	3.0	3.1
B1	0.6	0.7	0.84
C	0.22	0.25	0.35
D	6.2	6.5	6.7
E	3.3	3.5	3.7
F	-	4.6	6.8
F1	-	2.3	-
G	0.7	0.9	1.15
H	1.5	1.75	2.0
J	6.7	7.0	7.3
K	0.8	0.9	1.0

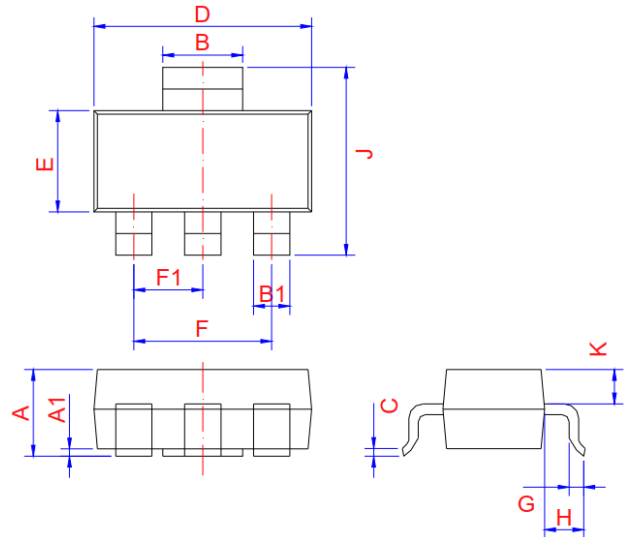

Outline Drawing- TO-92

SYMBOL	MM		
	MIN	NOM	MAX
A	4.45	4.60	5.20
B	4.32	4.60	5.33
C	3.18	3.55	4.19
D	0.407	-	0.533
E	0.50	-	0.80
F	-	1.10	-
G	-	1.27	-
H	-	2.30	-
J	0.36	0.38	0.50
K	12.7	-	15
N	2.04	2.30	2.66
P	1.80	-	2.30
V	-	-	4.50

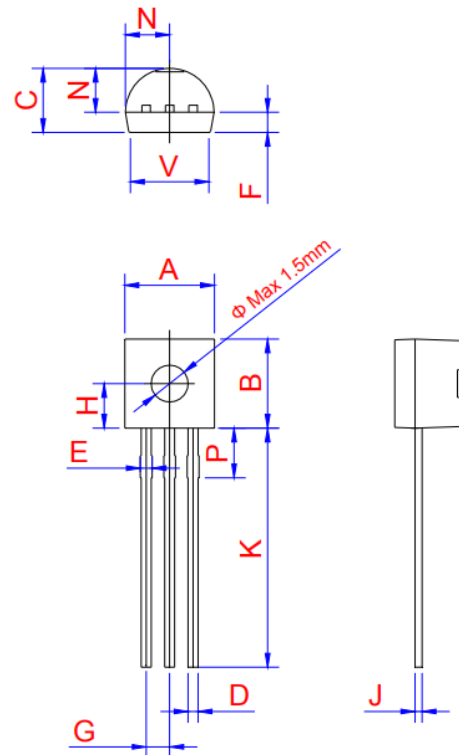

Outline Drawing- TO-252-4R

SYMBOL	MM		
	MIN	NOM	MAX
A	2.1	-	2.5
A2	0	-	0.2
B	0.66	-	0.91
B2	5.1	-	5.50
C	0.46	-	0.58
C2	0.43	-	0.61
D	5.9	-	6.3
D1	5.30REF		
E	6.4	-	6.8
E1	4.63	-	-
G	4.372	-	4.772
H	9.4	-	10.5
L	0.88	-	1.28
L2	1.35	-	1.75
V1	-	7°	-
V2	0°	-	8°

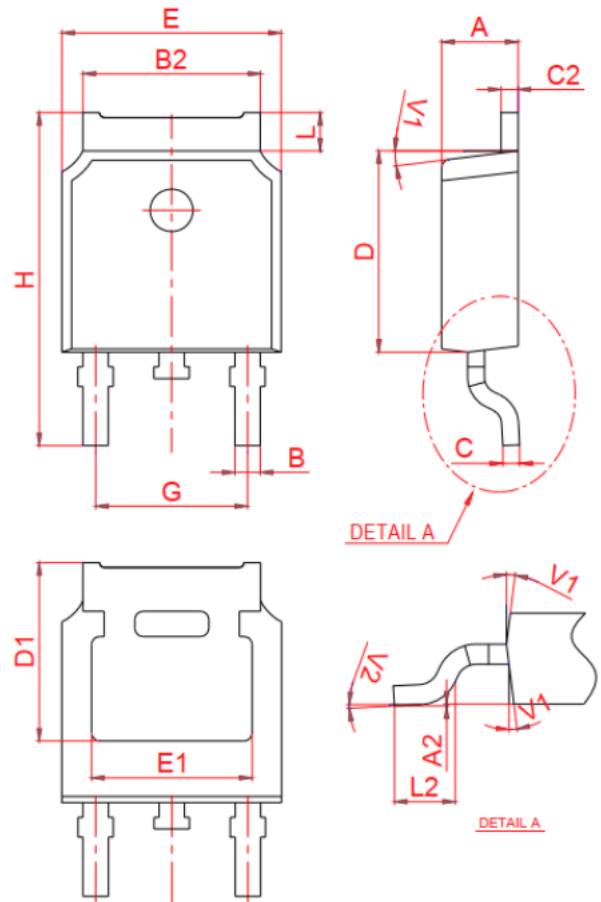

Outline Drawing- TO-220B Non-Ins

SYMBOL	MM		
	MIN	NOM	MAX
A	4.20	4.47	4.60
B	0.61	-	0.93
C	0.41	0.50	0.70
C2	1.20	1.27	1.42
C3	2.40	-	2.72
D	8.60	-	9.70
E	9.70	-	10.60
F	6.15	-	7.15
G	-	2.54	-
H	28	-	29.8
L1	-	3.75	-
L2	1.10	-	1.70
L3	2.55	-	2.95
V1	-	45°	-
Φ	3.65	3.75	3.85

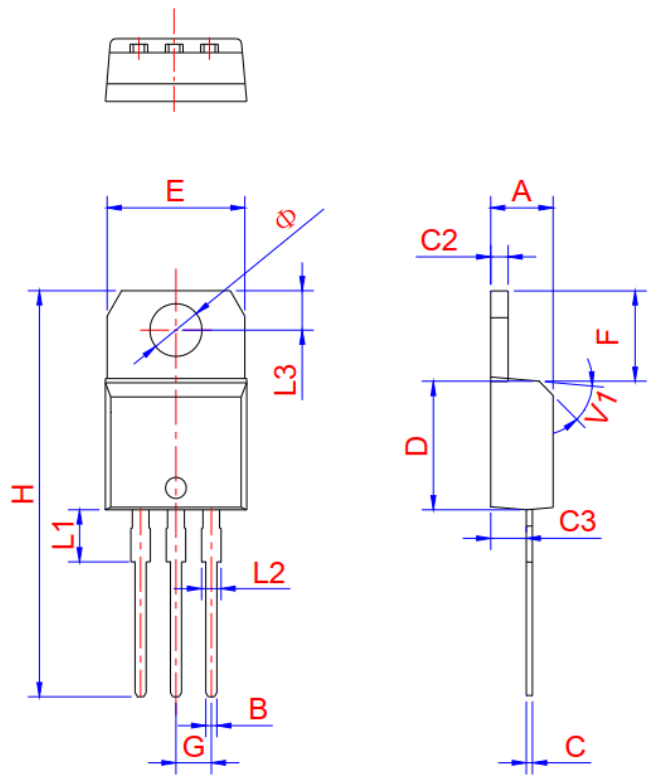

Marking Code:

For Example:

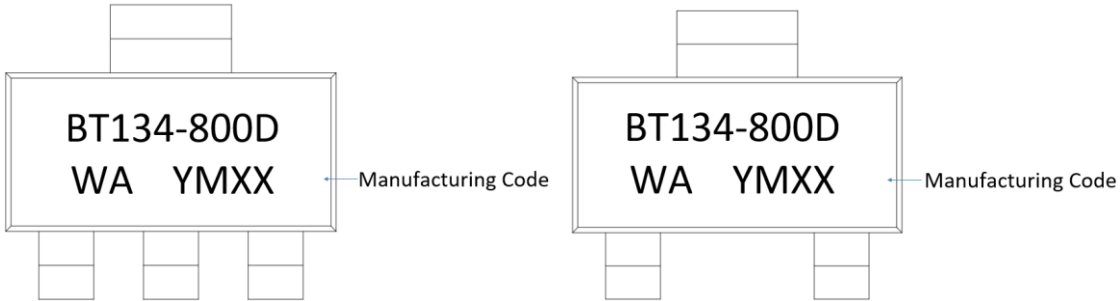

SOT-223-3L, SOT-223-2L

Note: The first line of printed content is the result of removing the package code from the part number system

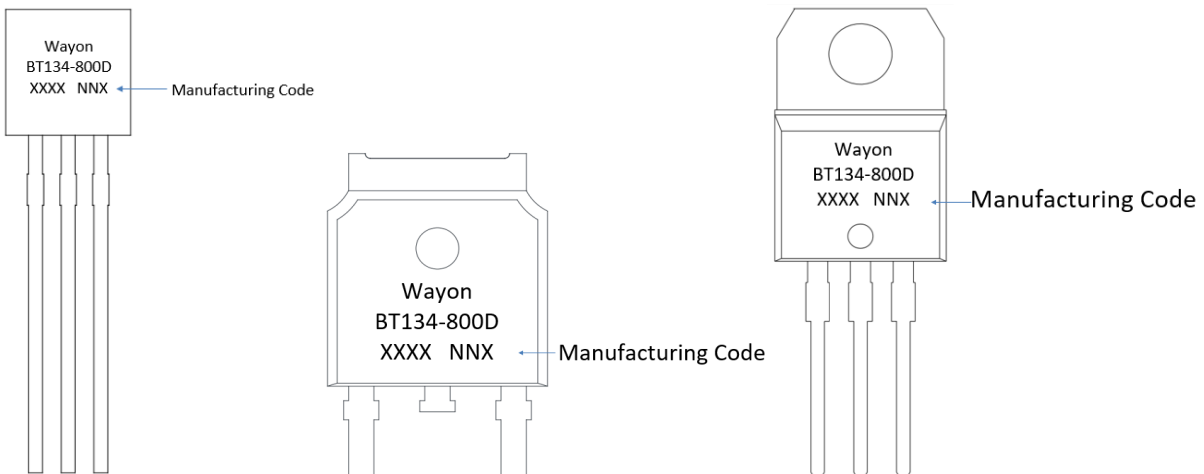

TO-92, TO-252-4R, TO-220B(No-Ins)

Note: The second line of printed content is the result of removing the package code from the part number system

Part Number System

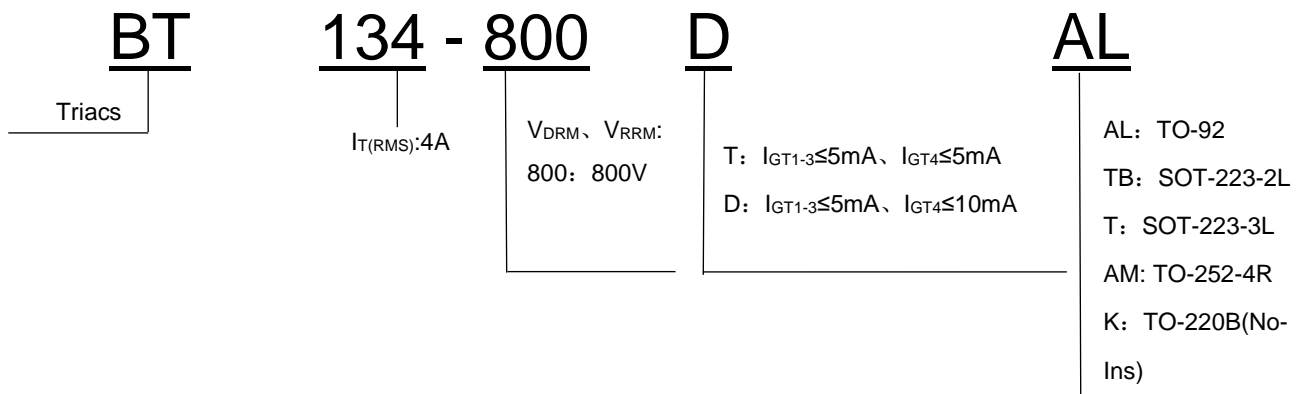

Package Information

Package	Base qty.	Delivery mode
SOT-223-2L	4000	Reel
TO-92	1000	Bulk Pack
SOT-223-3L	4000	Reel
TO-220B(No-Ins)	50	Tube
TO-252-4R	2500	Reel

Contact Information

No.1001, Shiwan(7) Road, Pudong District, Shanghai, P.R.China.201207

Tel: 86-21-50310888 Fax: 86-21-50757680 Email: market@way-on.com

WAYON website: <http://www.way-on.com>

For additional information, please contact your local Sales Representative.

WAYON® is registered trademarks of Wayon Corporation.

Product Specification Statement

The product specification aims to provide users with a reference regarding various product parameters, performance, and usage. It presents certain aspects of the product's performance in graphical form and is intended solely for users to select product and make product comparisons, enabling users to better understand and evaluate the characteristics and advantages of the product. It does not constitute any commitment, warranty, or guarantee.

The product parameters described in the product specification are numerical values, characteristics, and functions obtained through actual testing or theoretical calculations of the product in an independent or ideal state. Due to the complexity of product applications and variations in test conditions and equipment, there may be slight fluctuations in parameter test values. WAYON shall not guarantee that the actual performance of the product when installed in the customer's system or equipment will be entirely consistent with the product specification, especially concerning dynamic parameters. It is recommended that users consult with professionals for product selection and system design. Users should also thoroughly validate and assess whether the actual parameters and performance when installed in their respective systems or equipment meet their requirements or expectations. Additionally, users should exercise caution in verifying product compatibility issues, and WAYON assumes no responsibility for the application of the product.

WAYON strives to provide accurate and up-to-date information to the best of our ability. However, due to technical, human, or other reasons, WAYON cannot guarantee that the information provided in the product specification is entirely accurate and error-free. WAYON shall not be held responsible for any losses or damages resulting from the use or reliance on any information in these product specifications. WAYON reserves the right to revise or update the product specification and the products at any time without prior notice, and the user's continued use of the product specification is considered an acceptance of these revisions and updates. Prior to purchasing and using the product, users should verify the above information with WAYON to ensure that the product specification is the most current, effective, and complete. If users are particularly concerned about product parameters, please consult WAYON in detail or request relevant product test reports. Any data not explicitly mentioned in the product specification shall be subject to separate agreement.

Users are advised to pay attention to the parameter limit values specified in the product specification and maintain a certain margin in design or application to ensure that the product does not exceed the parameter limit values defined in the product specification. This precaution should be taken to avoid exceeding one or more of the limit values, which may result in permanent irreversible damage to the product, ultimately affecting the quality and reliability of the system or equipment.

The design of the product is intended to meet civilian needs and is not guaranteed for use in harsh environments or precision equipment. It is not recommended for use in systems or equipment such as medical devices, aircraft, nuclear power, and similar systems, where failures in these systems or equipment could reasonably be expected to result in personal injury. WAYON shall assume no responsibility for any consequences resulting from such usage.

Users should also comply with relevant laws, regulations, policies, and standards when using the product specification. Users are responsible for the risks and liabilities arising from the use of the product specification and must ensure that it is not used for illegal purposes. Additionally, users should respect the intellectual property rights related to the product specification and refrain from infringing upon any third-party legal rights. WAYON shall assume no responsibility for any disputes or controversies arising from the above-mentioned issues in any form.