

Features

- Small Body Outline Dimensions
- Protect one data line
- Low Clamping Voltage
- Low Capacitance
- Working Voltage:3.3V
- Low Leakage Current

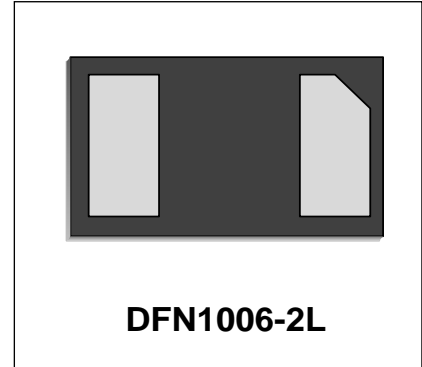

IEC COMPATIBILITY (EN61000-4)

- IEC 61000-4-2 (ESD) $\pm 20\text{kV}$ (air), $\pm 15\text{kV}$ (contact)
- IEC 61000-4-4 (EFT) 40A (5/50ns)
- IEC 61000-4-5 (Lightning) 7A (8/20 μs)

Mechanical Characteristics

- DFN1006-2L package
- Marking: Marking Code
- Packaging: Tape and Reel
- RoHS Compliant & HF
- Device meets MSL1 requirement

Applications

- USB 2.0 and USB 3.0
- HDMI 1.3 and HDMI 1.4
- SATA and ESATA
- DVI
- IEEE 1394
- PCI Express
- Portable Electronics
- Notebooks

Schematic & PIN Configuration

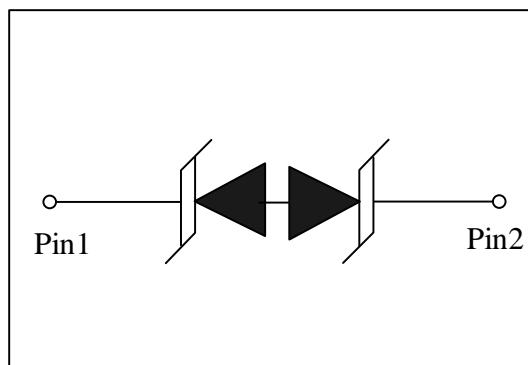

Absolute Maximum Rating

Rating	Symbol	Value	Units
Peak Pulse Power ($t_p = 8/20\mu s$)	P_{PP}	56	W
Peak Pulse Current ($t_p = 8/20\mu s$)	I_{PP}	7	A
Operating Temperature	T_J	-55 to +125	°C
Storage Temperature	T_{STG}	-55 to +150	°C

Electrical Parameters

Symbol	Parameter
I_{PP}	Reverse Peak Pulse Current
V_C	Clamping Voltage
V_{RWM}	Reverse Stand-Off Voltage
I_R	Reverse Leakage Current
V_{BR}	Reverse Breakdown Voltage
I_{BR}	Reverse Breakdown Current
V_T	Reverse Trigger Voltage
I_T	Reverse Trigger Current
V_H	Reverse Holding Voltage
I_H	Reverse Holding current

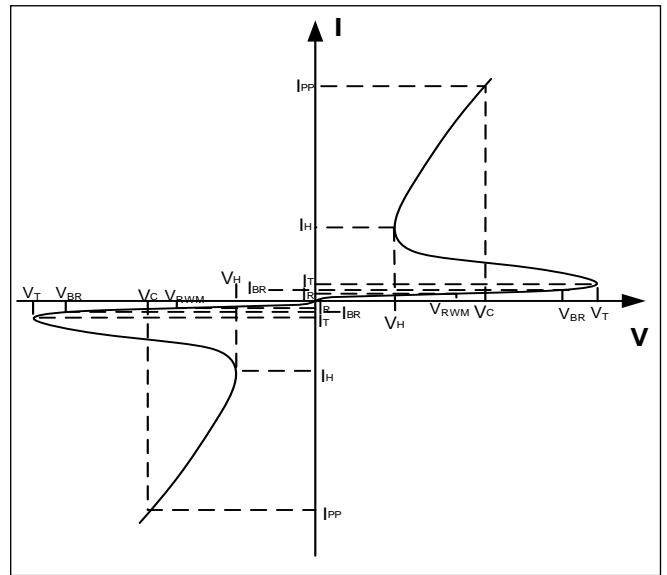

Electrical Characteristics(T=25°C unless otherwise noted)

WS03DTUF-BH						
Parameter	Symbol	Conditions	Minimum	Typical	Maximum	Units
Reverse Stand-Off Voltage	V_{RWM}				3.3	V
Reverse Breakdown Voltage	V_{BR}	$I_T=1mA$	3.7			V
Reverse Leakage Current	I_R	$V_{RWM}=3.3V,$			200	nA
Holding current	I_H	$T=25^\circ C$		5		mA
Clamping Voltage	V_C	$I_{PP}=7A, t_p=8/20\mu s$		6	8	V
ESD Clamping Voltage ¹	V_C	$I_{PP} = 4A$ $t_p = 0.2/100ns$		4.2		V
ESD Clamping Voltage ¹	V_C	$I_{PP} = 16A$ $t_p = 0.2/100ns$		9.2		V
Dynamic Resistance ^{1,2}	R_{DYN}	$TLP=0.2/100ns$		0.41		Ω
Junction Capacitance	C_j	$V_R = 2.5V, f = 1MHz$		0.5	0.6	pF

Notes : 1、 TLP Setting : $t_p=100ns, t_r=0.2ns, I_{TLP}$ and V_{TLP} sample window: $t_1=70ns$ to $t_2=90ns$.
 2、 Dynamic resistance calculated from $I_{PP}=4A$ to $I_{PP}=16A$ using "Best Fit".

Typical Characteristics

Figure 1: Peak Pulse Power Vs Pulse Time

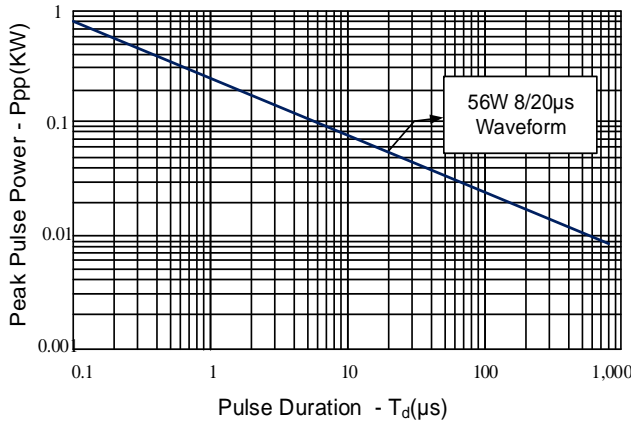

Figure 2: Power Derating Curve

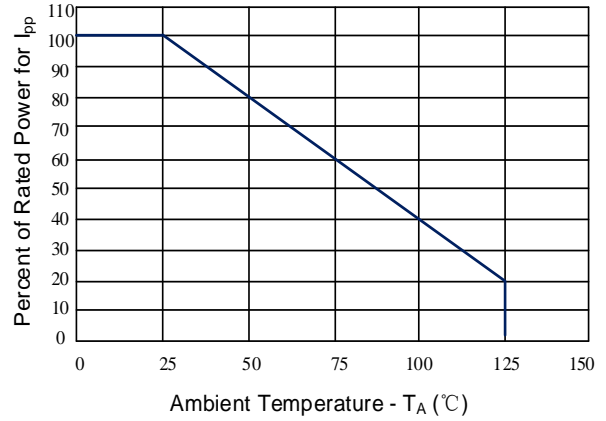

Figure 3: Clamping Voltage vs. Peak Pulse Current

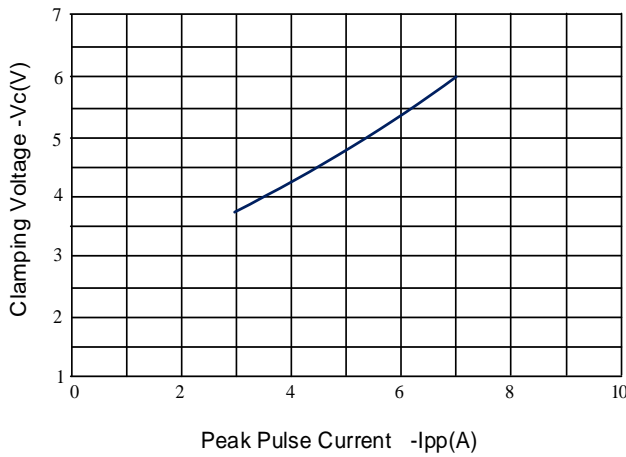

Figure 4: Normalized Junction Capacitance vs. Reverse Voltage

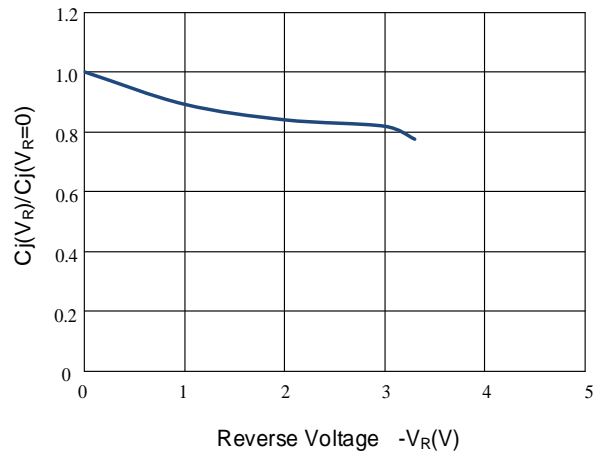

Figure 5: TLP Positive I-V Curve

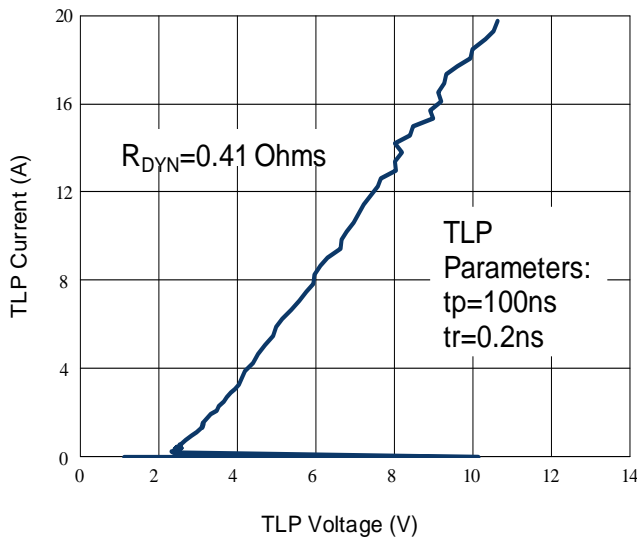
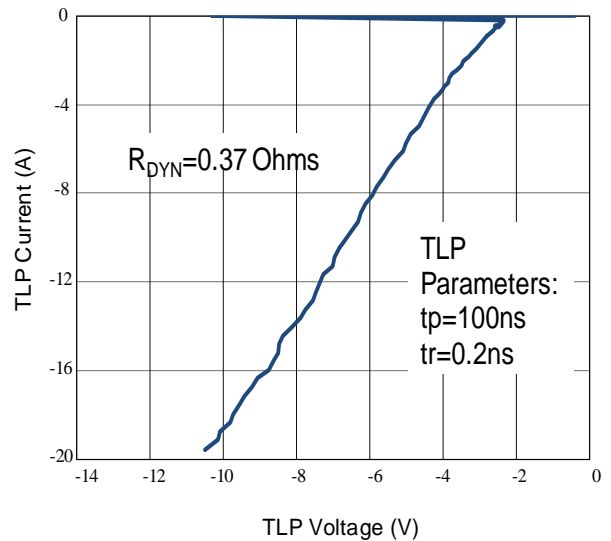
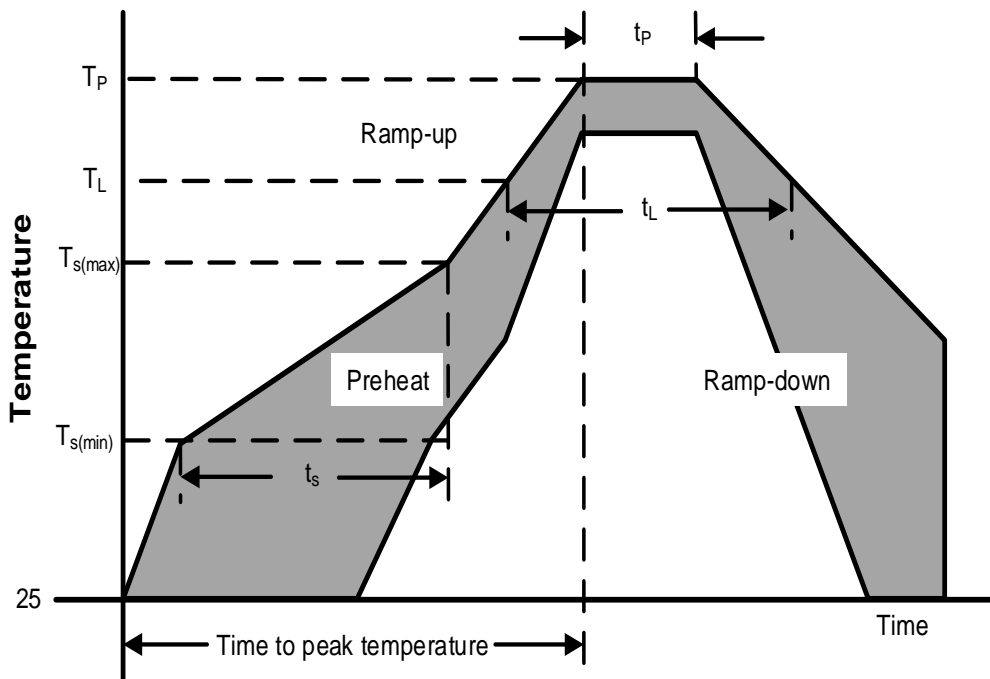

Figure 6: TLP Negative I-V Curve



Soldering Parameters

Reflow Condition		Pb – Free assembly
Pre Heat	Temperature Min ($T_{s(min)}$)	150°C
	Temperature Max ($T_{s(max)}$)	200°C
	Time (min to max) (t_s)	60 – 190 secs
Average ramp up rate (Liquidus Temp) (T_L) to peak		5°C/second max
$T_{s(max)}$ to T_L —Ramp-up Rate		5°C/second max
Reflow	Temperature (T_L) (Liquidus)	217°C
	Temperature (t_L)	60 – 150 seconds
Peak Temperature (T_P)		260+0/-5 °C
Time within actual peak Temperature (t_p)		20 – 40 seconds
Ramp-down Rate		5°C/second max
Time 25°C to peak Temperature (T_P)		8 minutes Max.
Do not exceed		280°C



Tape And Reel Information

Reel Dimensions

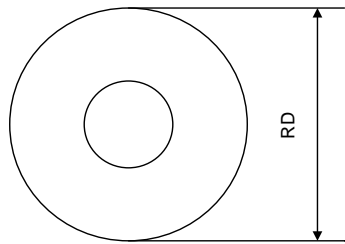

Tape Dimensions

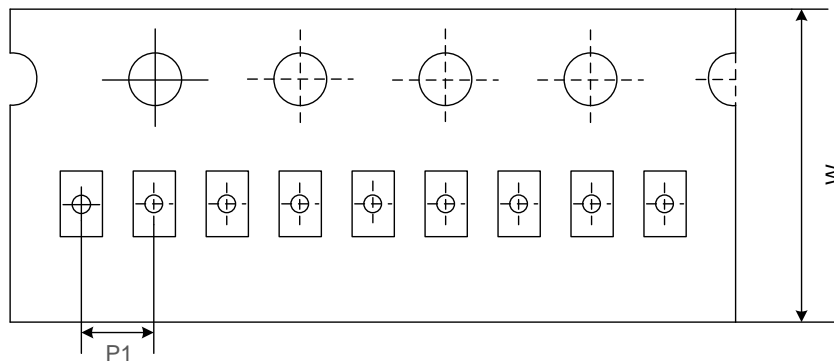

Quadrant Assignments For PIN1 Orientation In Tape

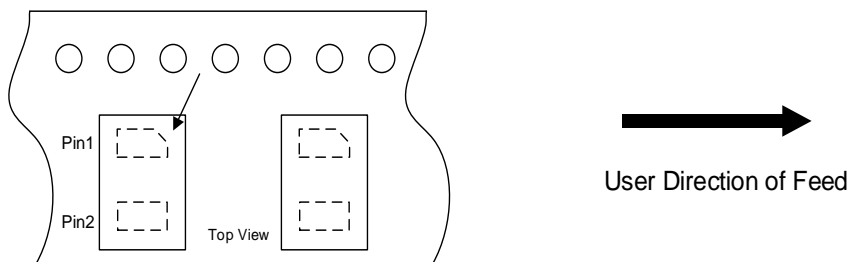

RD	Reel Dimensions	7 inch
W	Overall width of the carrier tape	8 mm
P1	Pitch between successive cavity centers	2mm

Outline Drawing –DFN1006-2L

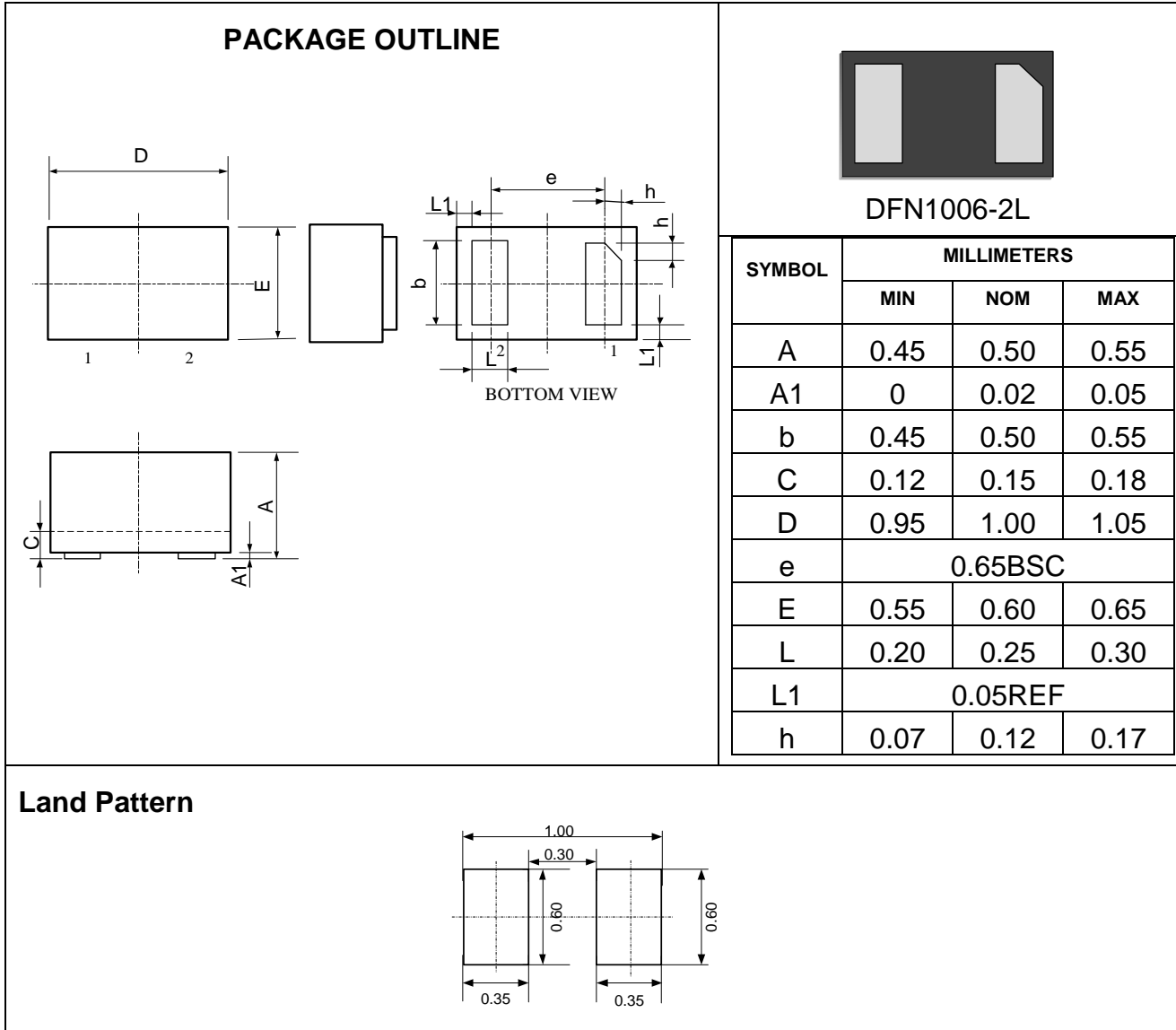

Marking Codes

Part Number	Marking Code
WS03DTUF-BH	<div style="border: 1px solid black; padding: 5px; display: inline-block;"> K SX </div> <small>KS=Specific Device Code X=Month Code</small>

Package Information

Qty: 10k/Reel

CONTACT INFORMATION

No.1001, Shiwan (7) Road, Pudong District, Shanghai, P.R.China.201207

Tel: 86-21-50310888 Fax: 86-21-50757680 Email: market@way-on.com

WAYON website: <http://www.way-on.com>

For additional information, please contact your local Sales Representative.

WAYON ® is registered trademark of WAYON Corporation.

Product Specification Statement

1. The product specification aims to provide users with a reference regarding various product parameters, performance, and usage. It presents certain aspects of the product's performance in graphical form and is intended solely for users to select product and make product comparisons, enabling users to better understand and evaluate the characteristics and advantages of the product. It does not constitute any commitment, warranty, or guarantee.
2. The product parameters described in the product specification are numerical values, characteristics, and functions obtained through actual testing or theoretical calculations of the product in an independent or ideal state. Due to the complexity of product applications and variations in test conditions and equipment, there may be slight fluctuations in parameter test values. WAYON shall not guarantee that the actual performance of the product when installed in the customer's system or equipment will be entirely consistent with the product specification, especially concerning dynamic parameters. It is recommended that users consult with professionals for product selection and system design. Users should also thoroughly validate and assess whether the actual parameters and performance when installed in their respective systems or equipment meet their requirements or expectations. Additionally, users should exercise caution in verifying product compatibility issues, and WAYON assumes no responsibility for the application of the product.
3. WAYON strives to provide accurate and up-to-date information to the best of our ability. However, due to technical, human, or other reasons, WAYON cannot guarantee that the information provided in the product specification is entirely accurate and error-free. WAYON shall not be held responsible for any losses or damages resulting from the use or reliance on any information in these product specifications. WAYON reserves the right to revise or update the product specification and the products at any time without prior notice, and the user's continued use of the product specification is considered an acceptance of these revisions and updates. Prior to purchasing and using the product, users should verify the above information with WAYON to ensure that the product specification is the most current, effective, and complete. If users are particularly concerned about product parameters, please consult WAYON in detail or request relevant product test reports. Any data not explicitly mentioned in the product specification shall be subject to separate agreement.
4. Users are advised to pay attention to the parameter limit values specified in the product specification and maintain a certain margin in design or application to ensure that the product does not exceed the parameter limit values defined in the product specification. This precaution should be taken to avoid exceeding one or more of the limit values, which may result in permanent irreversible damage to the product, ultimately affecting the quality and reliability of the system or equipment.
5. The design of the product is intended to meet civilian needs and is not guaranteed for use in harsh environments or precision equipment. It is not recommended for use in systems or equipment such as medical devices, aircraft, nuclear power, and similar systems, where failures in these systems or equipment could reasonably be expected to result in personal injury. WAYON shall assume no responsibility for any consequences resulting from such usage.
6. Users should also comply with relevant laws, regulations, policies, and standards when using the product specification. Users are responsible for the risks and liabilities arising from the use of the product specification and must ensure that it is not used for illegal purposes. Additionally, users should respect the intellectual property rights related to the product specification and refrain from infringing upon any third-party legal rights. WAYON shall assume no responsibility for any disputes or controversies arising from the above-mentioned issues in any form.