



WSRSIC010120NNI

SILICON CARBIDE SCHOTTKY DIODE

Features

- 10A Silicon Carbide Schottky Diode
- Excellent high temperature stability
- Low forward voltage
- High forward surge capability
- 175°C Operating Junction Temperature
- Reduced temperature dependence

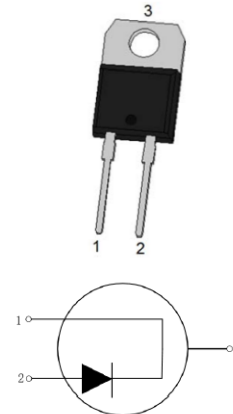

Mechanical Data

- Case: TO-220AC insulated
 - Ceramic Package Provides 2.5KV Isolation
 - Electrically Isolated Package

Absolute Maximum Ratings (T_c=25°C Unless otherwise specified)

Parameter	Symbol	Value	Unit
Repetitive Peak Reverse Voltage	V _{RRM}	1200	V
Surge Peak Reverse Voltage	V _{RSM}	1200	V
DC Blocking Voltage	V _R	1200	V
Maximum Average Forward Rectified Current at T _C =143°C	I _F	10	A
Surge(Non-Repetitive)Forward Current @ T _p =10ms Half Sine Wave T _C =25°C	I _{FSM}	95	A
Power Dissipation T _C =25°C	P _{tot}	93.7	W
Thermal Resistance(between Junction and Case)	R _{θ(J-C)}	1.6 (Typ.)	°C/W
Junction and Storage Temperature	T _J T _{STG}	-55 ~ +175	°C

Electronics Characteristics (T_C=25°C Unless otherwise specified)

Parameter	Symbol	Typ.	Max.	Unit
Maximum Instantaneous Forward Voltage @I _F =10A T _J =25°C	V _F	1.4	1.8	V
Maximum Instantaneous Forward Voltage @I _F =10A T _J =175°C		2	/	

SILICON CARBIDE SCHOTTKY DIODE

WSRSIC010120NNI

Total Capacitance @ f=1MHZ T _J =25°C V _R =0V		705		
Total Capacitance @ f=1MHZ T _J =25°C V _R =400V	C	49	/	pF
Total Capacitance @ f=1MHZ T _J =25°C V _R =800V		41		
Total Capacitive Charge @ V _R =800V	Q _C	41	/	nC
Reverse leakage current @ V _R =V _{RWM} T _J =25°C		1	100	
Reverse leakage current @ V _R =V _{RWM} T _J =175°C	I _R	15	/	μA

Typical Characteristics

Fig.1-Forward Characteristics

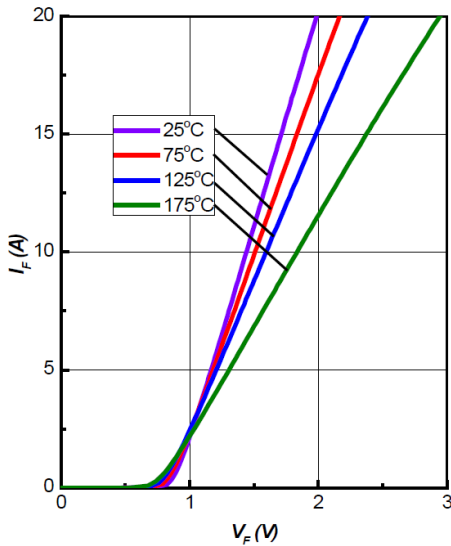

Fig.2-Reverse Characteristics

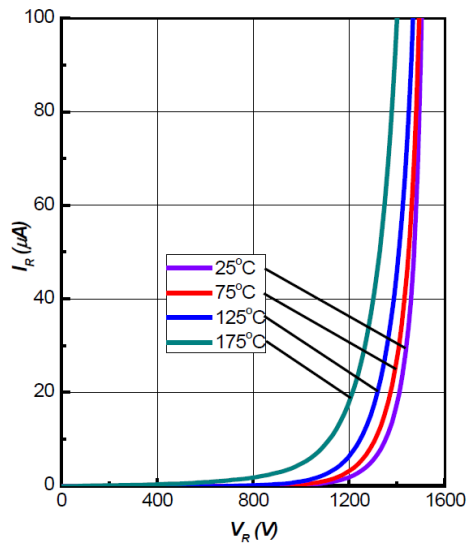

Fig.3-Total Capacitance Charge VS Reverse Voltage

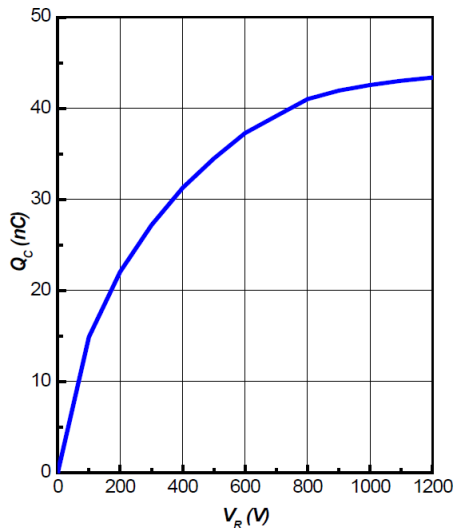
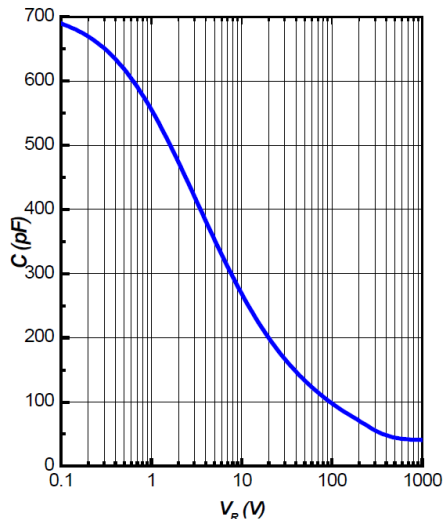
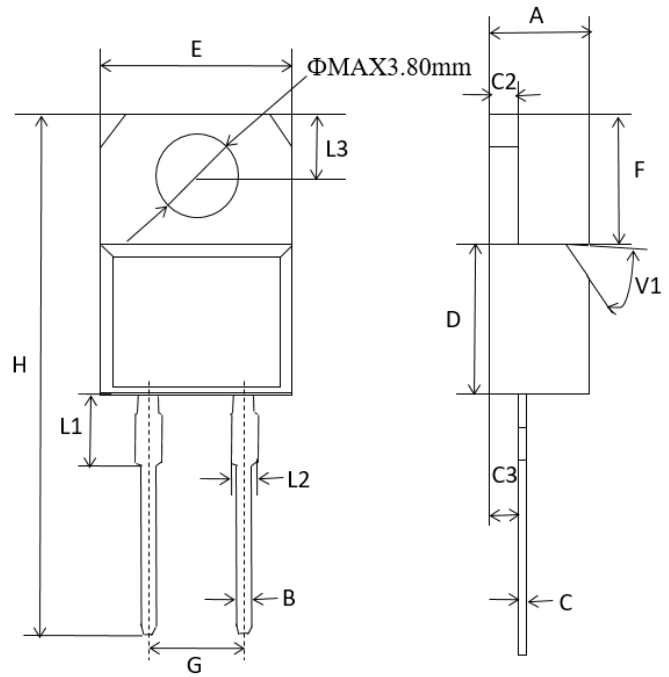

Fig.4-Capacitance VS Reverse Voltage



Outline Drawing

SYMBOL	MM		
	MIN	NOM	MAX
A	4.1		4.7
B	0.6		0.95
C	0.4		0.75
C2	1.1		1.45
C3	2.3		2.75
D	8.5		9.8
E	9.65		10.65
F	6.1		7.2
G		5.08	
H	27.5		29.9
L1		3.75	
L2	1.1		1.7
L3	2.5		2.95
V1		45°	



Marking Code

Part Number	WSRSIC010120NNI
Marking Code	W010120NNI

Part Number System

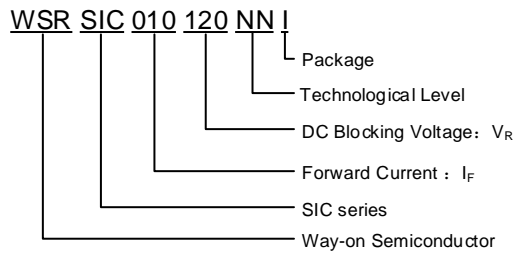

Package Information

Quantity per tube: 50pcs

Contact Information

No.1001, Shiwan(7) Road, Pudong District, Shanghai, P.R.China.201207

Tel: 021-68969993 Fax: 86-21-50757680 Email: market@way-on.com

WAYON website: <http://www.way-on.com>

For additional information, please contact your local Sales Representative.

WAYON® is registered trademarks of Wayon Corporation.

*Specifications are subject to change without notice.
The device characteristics and parameters in this data sheet can and do vary in different applications and actual device performance may vary over time.
Users should verify actual device performance in their specific applications.*