

Power Transient Voltage Suppressor

Features

- 600 watts Peak Pulse Power (10/1000 μ s)
- Unidirectional Protection
- Fast Response Time : Typically < 1ns
- Excellent Clamping Capability
- Built-in Strain relief
- Low inductance
- Low profile package
- High temperature solder:260°C/10 seconds at terminal

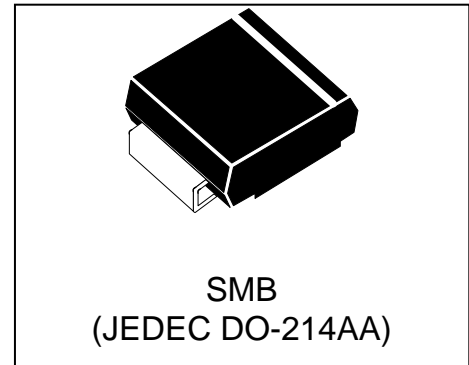

Mechanical Characteristics

- JEDEC DO-214AA package
- Molding compound flammability rating: UL 94V-0
- Marking: see marking code
- Packaging : Tape and Reel per EIA 481
- RoHS Compliant

Applications

- I/O Interfaces
- Power lines
- Automotive and Telecommunication
- Computers & Consumer Electronics
- Industrial Electronics

| Absolute Maximum Rating | | | |
|---|------------------|-------------|-------|
| Rating | Symbol | Value | Units |
| Peak Pulse Power (tp =10/1000 μ s) (see Note1,2& 3) | P _{PPM} | 600 | Watts |
| Peak pulse current (10/1000 μ s) (see Note2&3) | I _{PPM} | 35.3 | A |
| Power Dissipation on infinite heat sink T _L = 50 °C (Fig4) | P _D | 5.0 | W |
| Operating Junction Temperature range | T _J | -40 to +125 | °C |
| Storage Temperature range | T _{STG} | -40 to +125 | °C |

Note1: Peak Pulse Power Rating as Pulse Width ,per Fig1.

Note2: Peak Pulse Power or Current Derated above T_A=25°C Per Fig. 2 and Non-Repetitive Current Pulse,Per Fig.3.

Note3: Mounted on 5.0x5.0mm² copper pad to each terminal.

Note4: 8.3ms Single Half Sine Wave or Equivalent Square Wave.

Pin Configuration

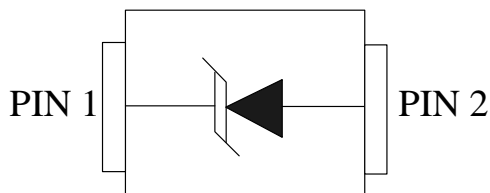

Electrical Characteristics

| Symbol | Parameter |
|-----------|---|
| I_{PP} | Maximum Reverse Peak Pulse Current |
| V_C | Clamping Voltage @ I_{PP} |
| V_{RWM} | Working Peak Reverse Voltage |
| I_R | Maximum Reverse Leakage Current @ V_{RWM} |
| V_{BR} | Breakdown Voltage @ I_T |
| I_T | Test Current |

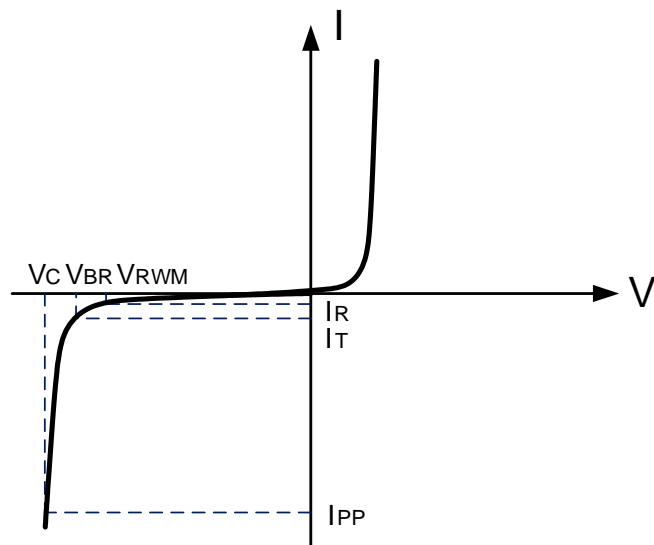

| WS10P6SMBS | | | | | |
|---------------------------|-----------|----------------------------------|---------|---------|---------|
| Parameter | Symbol | Conditions | Minimum | Maximum | Units |
| Reverse Stand-Off Voltage | V_{RWM} | | | 10 | V |
| Reverse Breakdown Voltage | V_{BR} | $I_T=1mA$ | 11.1 | 13.0 | V |
| Reverse Leakage Current | I_R | $V_{RWM}=10V$ | | 5 | μA |
| Clamping Voltage | V_C | $I_{PP}=35.3A, t_p=10/1000\mu s$ | | 17.0 | V |

Typical Characteristics

Figure 1: Peak Pulse Power Rating Curve

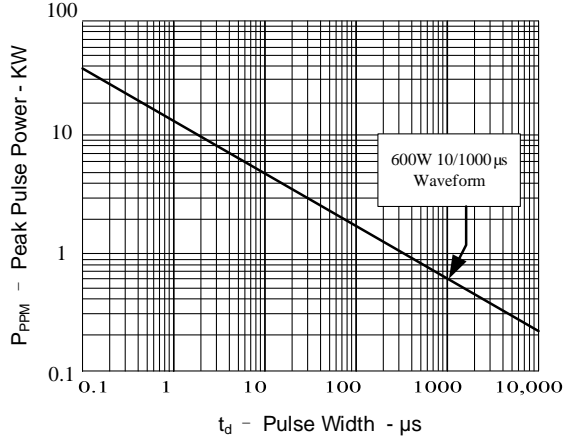

Figure 2: Pulse Derating Curve

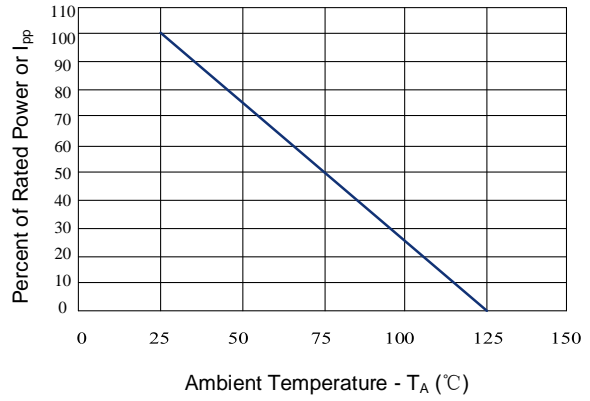

Figure 3: Pulse Waveform

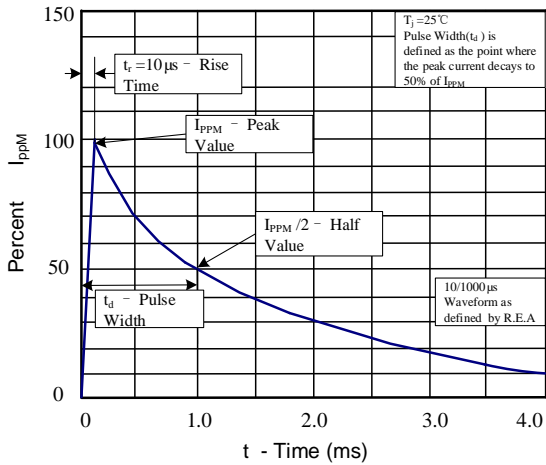
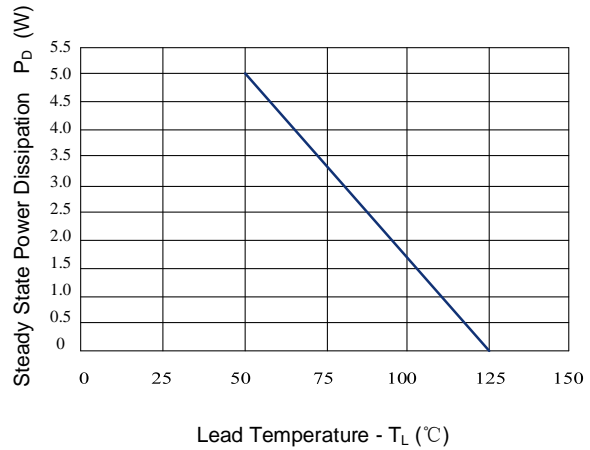
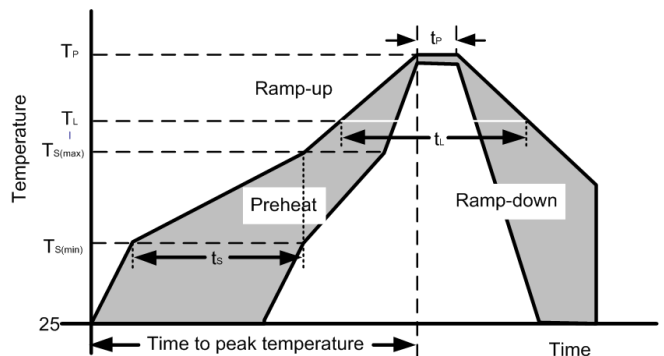

Figure 4: Steady State Power Dissipation Derating Curve



Recommended Soldering Parameters

| Reflow Condition | | |
|--|----------------------------------|-------------------------|
| Pre-Heat | Temperature min ($T_{S(min)}$) | 150°C |
| | Temperature max ($T_{S(max)}$) | 200°C |
| | Time (min to max) (t_s) | 60-190 s |
| Average ramp up rate (Liquidus Temp) (T_L) to peak | | 3°C/s max |
| Ts(max) to TL - Ramp-up Rate | | 3°C/s max |
| Reflow | Temperature (T_L) (Liquidus) | 217°C |
| | Temperature (t_L) | 60-150 s |
| Peak Temperature (T_P) | | 260 ^{+0/-5} °C |
| Time within actual peak Temperature (t_p) | | 20-40 s |
| Ramp-down Rate | | 5°C/s max |
| Time 25°C to peak Temperature (T_P) | | 8 minutes max |
| Do not exceed | | 260°C |



Outline Drawing – SMB(DO-214AA)

| Ref. (mm) | Millimeters | |
|-----------|-------------|------|
| | Min. | Max. |
| A | 2.13 | 2.60 |
| A1 | - | 0.30 |
| B | 1.90 | 2.20 |
| E | 4.10 | 4.75 |
| E1 | 5.21 | 5.59 |
| D | 3.30 | 3.94 |
| L | 0.76 | 1.52 |

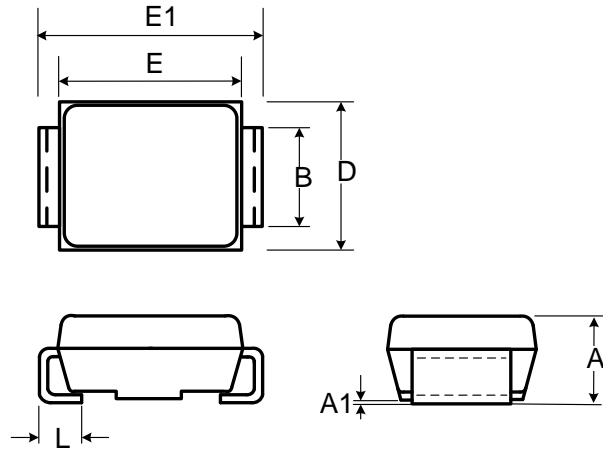

Recommended Solder Pad Layout

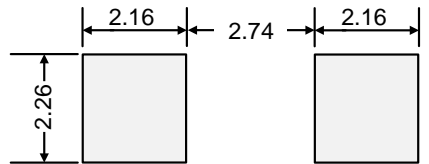

Dimensions in mm

Marking Code

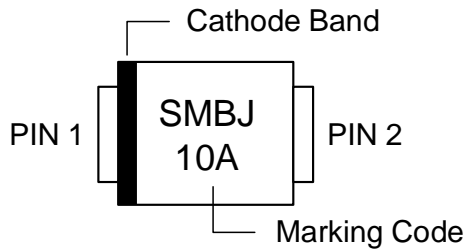

Package Information

| Package Type | Description | Quantity (pcs) |
|---------------|----------------------------|----------------|
| SMB(DO-214AA) | Tape & Reel -12mm/13" tape | 3000 |

Contact Information

No.1001, Shiwan(7) Road, Pudong District, Shanghai, P.R.China.201207

Tel: 86-21-68969993 Fax: 86-21-50757680 Email: market@way-on.com

WAYON website: <http://www.way-on.com>

For additional information, please contact your local Sales Representative.

WAYON ® are registered trademarks of Wayon Corporation.

*Specifications are subject to change without notice.
The device characteristics and parameters in this data sheet can and do vary in different applications and actual device performance may vary over time.
Users should verify actual device performance in their specific applications.*