

P-Channel Enhancement MOSFET

Features

- Way-on Small Signal MOSFETs
- $V_{DS} = -20V$, $I_D = -5.6A$
 $R_{DS(on)} < 23m\Omega @ V_{GS} = -4.5V$
 $R_{DS(on)} < 30m\Omega @ V_{GS} = -2.5V$
- Trench LV MOSFET Technology

Mechanical Characteristics

- SOT-23-6L Package
- Marking : Making Code
- RoHS Compliant

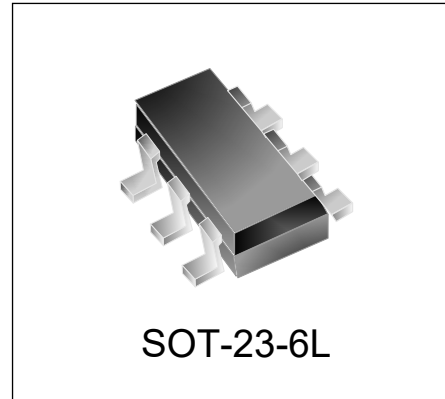

Schematic & PIN Configuration

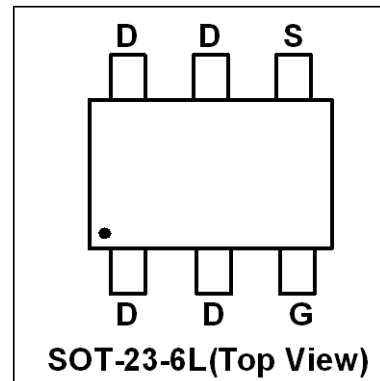
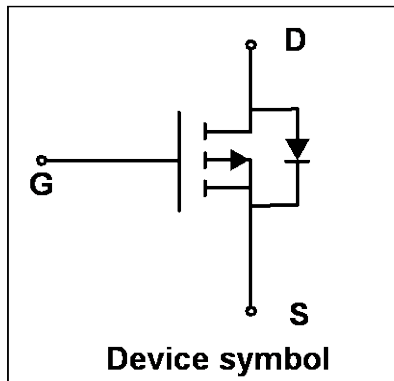

Absolute Maximum Rating ($T_A=25^\circ C$ unless otherwise noted)

Rating		Symbol	Value	Unit
Drain-Source Voltage		V_{DS}	-20	V
Gate-Source Voltage		V_{GS}	± 12	V
Continuous Drain Current	$T_A=25^\circ C$	I_D	-5.6	A
Pulsed Drain Current ¹		I_{DM}	-22.4	A
Power Dissipation	$T_A=25^\circ C$	P_D	2	W
Operating Junction and Storage Temperature Range		T_J, T_{STG}	-55 to 150	$^\circ C$

Thermal Characteristics

Rating	Symbol	Value	Unit
Thermal Resistance from Junction to Ambient ²	$R_{\theta JA}$	62.5	$^\circ C/W$

Electrical Characteristics (T_J=25°C unless otherwise noted)

Parameter	Symbol	Conditions	Min.	Typ.	Max.	Unit
Static Characteristics						
Drain-Source Breakdown Voltage	V _{(BR)DSS}	V _{GS} = 0V, I _D = -250μA	-20	-	-	V
Gate-Source Leakage	I _{GSS}	V _{DS} = 0V, V _{GS} = ±12V	-	-	±100	nA
Zero Gate Voltage Drain Current	I _{DSS}	V _{DS} = -20V, V _{GS} = 0V	-	-	-1	μA
Gate-Source Threshold voltage	V _{GS(th)}	V _{DS} = V _{GS} , I _D = -250μA	-0.4	-0.65	-1	V
Drain-Source on-State Resistance ³	R _{DS(on)}	V _{GS} = -4.5V, I _D = -3A	-	16	23	mΩ
		V _{GS} = -2.5V, I _D = -1A	-	19	30	
Dynamic Characteristics⁴						
Input Capacitance	C _{iss}	V _{GS} = 0V, V _{DS} = -10V, f = 1MHz	-	1500	-	pF
Output Capacitance	C _{oss}		-	225	-	
Reverse Transfer Capacitance	C _{rss}		-	200	-	
Switching Characteristics⁴						
Total Gate Charge	Q _g	V _{GS} = -4.5V, V _{DS} = -10V, I _D = -3A	-	14.2	-	nC
Gate-Source Charge	Q _{gs}		-	2	-	
Gate-Drain Charge	Q _{gd}		-	3.5	-	
Turn-on Delay Time	t _{d(on)}	V _{GS} = -4.5V, V _{DD} = -10V , I _D = -3A, R _G = 3Ω	-	18	-	ns
Rise Time	t _r		-	27	-	
Turn-off Delay time	t _{d(off)}		-	23	-	
Fall Time	t _f		-	6.5	-	
Source-Drain Body Diode Characteristics						
Diode Forward Voltage ³	V _{SD}	I _S = -3A, V _{GS} = 0V	-	-	-1.2	V
Continuous Source Current	I _S		-	-	-5.6	A

Notes:

1. Repetitive rating, pulse width limited by junction temperature T_{J(MAX)}=150°C.
2. The data tested by surface mounted on a 1 inch² FR-4 board with 2OZ copper, The value in any given application depends on the user's specific board design.
3. Pulse Test: Pulse width≤300μs, duty cycle≤2%.
4. This value is guaranteed by design hence it is not included in the production test.

Typical Characteristics

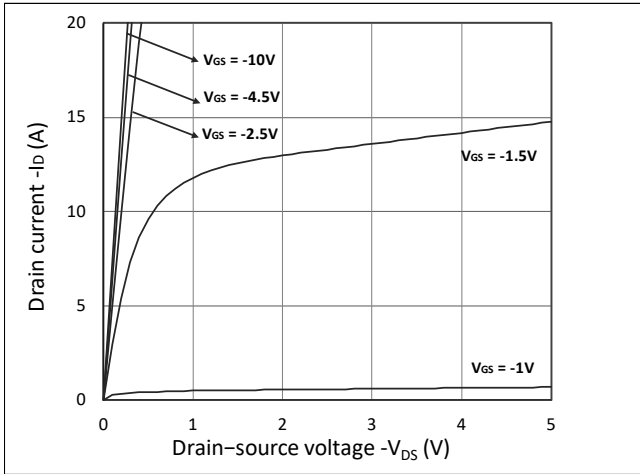

Figure 1. Output Characteristics

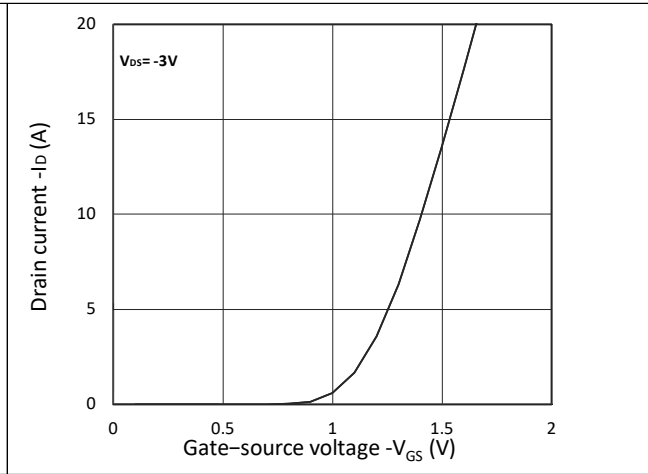

Figure 2. Transfer Characteristics

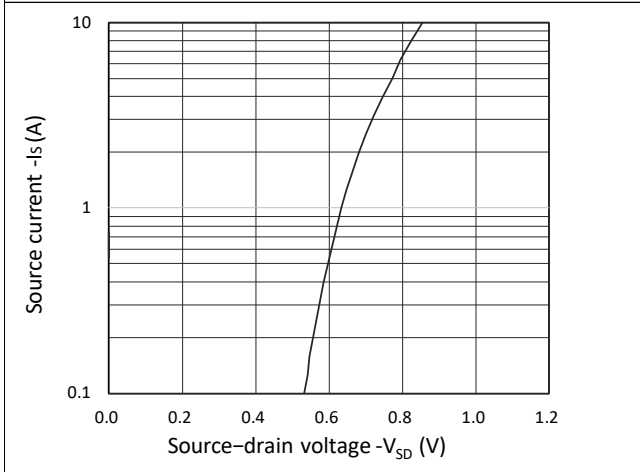

Figure 3. Forward Characteristics of Reverse

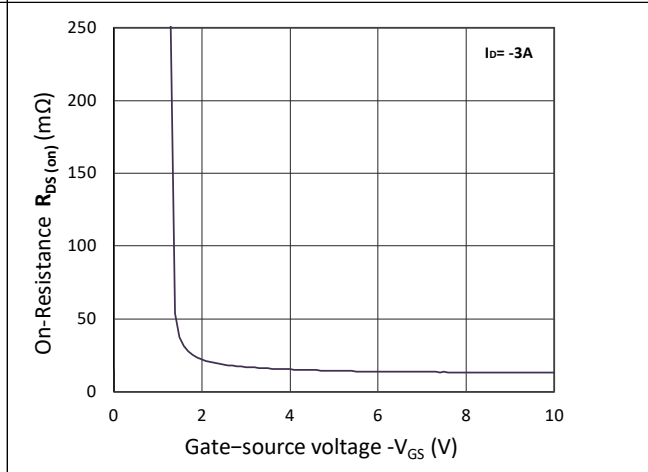

Figure 4. $R_{DS(ON)}$ vs. V_{GS}

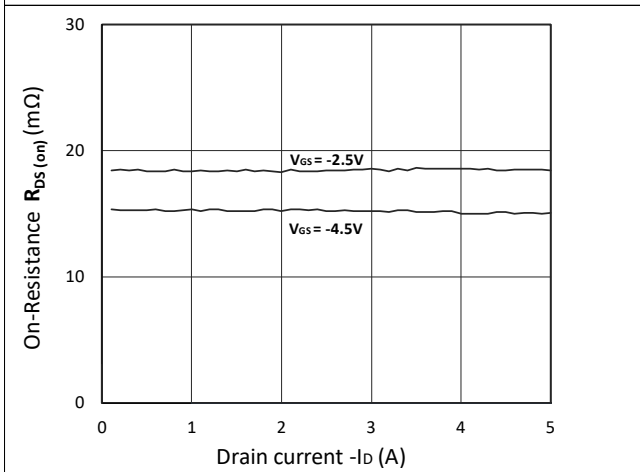

Figure 5. $R_{DS(ON)}$ vs. I_D

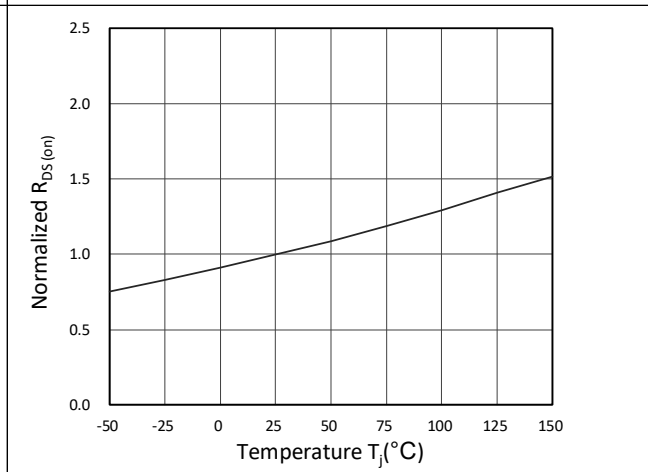

Figure 6. Normalized $R_{DS(ON)}$ vs. Temperature

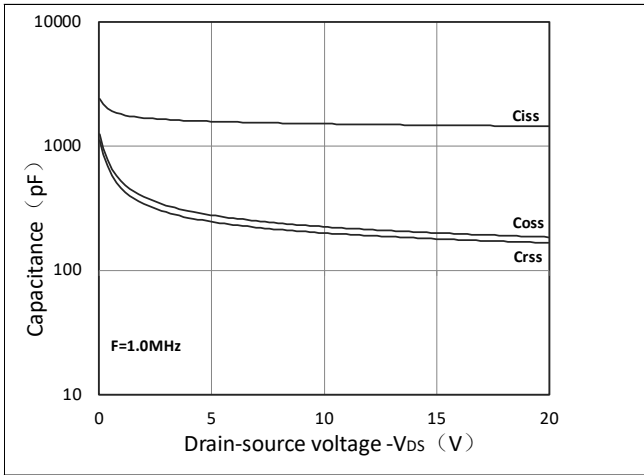

Figure 7. Capacitance Characteristics

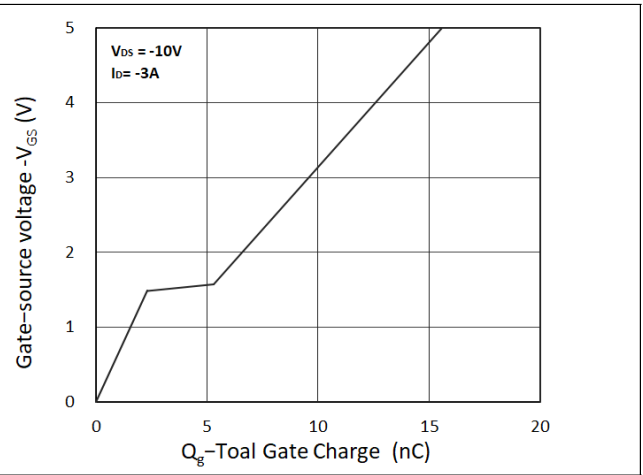
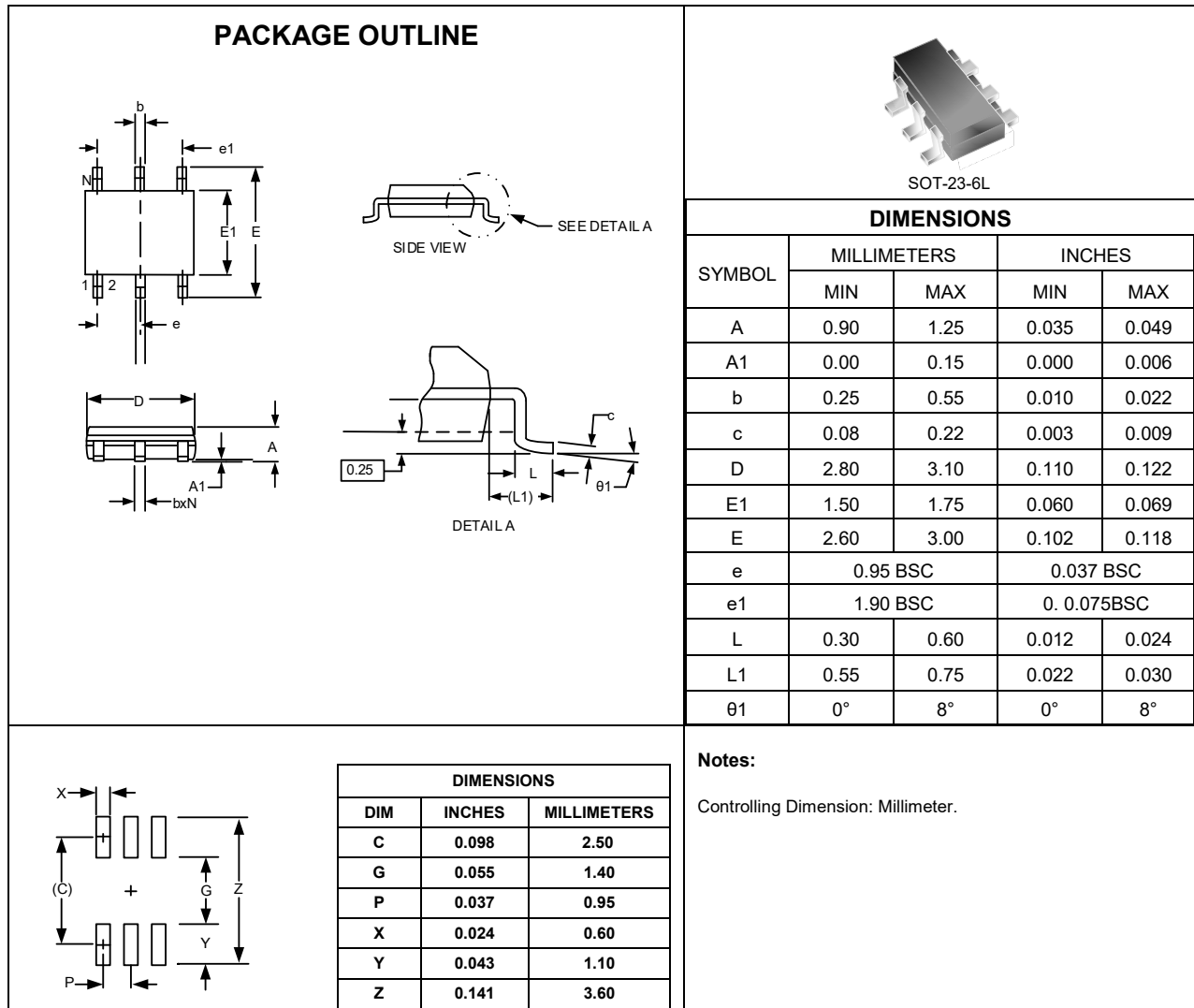

Figure 8. Gate Charge Characteristics

Outline Drawing – SOT-23-6L



Marking Codes

Part Number	WM02P56M3
Marking Code	

Package Information

Qty: 3k/Reel

CONTACT INFORMATION

No.1001, Shiwan (7) Road, Pudong District, Shanghai, P.R.China.201207

Tel: 86-21-68969993 Fax: 86-21-50757680 Email: market@way-on.com

WAYON website: <http://www.way-on.com>

For additional information, please contact your local Sales Representative.

WAYON® is registered trademark of Wayon Corporation.

*Specifications are subject to change without notice.
The device characteristics and parameters in this data sheet can and do vary in different applications and actual device performance may vary over time.
Users should verify actual device performance in their specific applications.*