

120V N-Channel Enhancement Mode Power MOSFET

Description

WMO15N12TS uses advanced power trench technology that has been especially tailored to minimize the on-state resistance and yet maintain superior switching performance.

Features

- $V_{DS} = 120V$, $I_D = 14.5A$
 $R_{DS(on)} < 160m\Omega @ V_{GS} = 10V$
 $R_{DS(on)} < 170m\Omega @ V_{GS} = 4.5V$
- High Speed Power Smooth Switching, Logic Level
- Low Gate Charge
- 100% EAS Guaranteed

Applications

- Power Management Switches
- DC/DC Converter

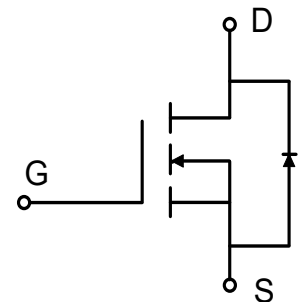
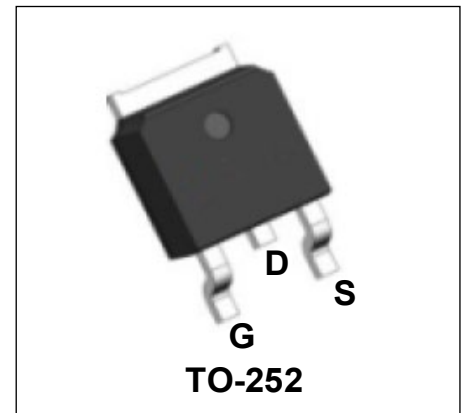

Absolute Maximum Ratings ($T_A = 25^\circ C$, unless otherwise noted)

Parameter		Symbol	Value	Unit
Drain-Source Voltage		V_{DS}	120	V
Gate-Source Voltage		V_{GS}	± 20	V
Continuous Drain Current	$T_C = 25^\circ C$	I_D	14.5	A
	$T_C = 100^\circ C$		9.2	
Pulsed Drain Current ¹		I_{DM}	58	A
Single Pulse Avalanche Energy ²		EAS	20	mJ
Total Power Dissipation	$T_C = 25^\circ C$	P_D	66	W
Operating Junction and Storage Temperature Range		T_J, T_{STG}	-55 to 150	$^\circ C$

Thermal Characteristics

Parameter	Symbol	Value	Unit
Thermal Resistance from Junction-to-Ambient ³	$R_{\theta JA}$	30	$^\circ C/W$
Thermal Resistance from Junction-to-Case	$R_{\theta JC}$	1.9	$^\circ C/W$

Electrical Characteristics (T_J = 25°C, unless otherwise noted)

Parameter	Symbol	Test Conditions	Min.	Typ.	Max.	Unit
Static Characteristics						
Drain-Source Breakdown Voltage	V_{(BR)DSS}	V _{GS} = 0V, I _D = 250μA	120	-	-	V
Gate-body Leakage current	I_{GSS}	V _{DS} = 0V, V _{GS} = ±20V	-	-	±100	nA
Zero Gate Voltage Drain Current	I_{DSS}	V _{DS} = 120V, V _{GS} = 0V	T _J =25°C	-	1	μA
			T _J =100°C	-	100	
Gate-Threshold Voltage	V_{GS(th)}	V _{DS} = V _{GS} , I _D = 250μA	1	2	3	V
Drain-Source On-Resistance ⁴	R_{DS(on)}	V _{GS} = 10V, I _D = 10A	-	120	160	mΩ
		V _{GS} = 4.5V, I _D = 6A	-	125	170	
Forward Transconductance ⁴	g_{fs}	V _{DS} = 10V, I _D = 10A	-	14.5	-	S
Dynamic Characteristics⁵						
Input Capacitance	C_{iss}	V _{GS} = 0V, V _{DS} = 60V, f = 1MHz	-	1076	-	pF
Output Capacitance	C_{oss}		-	27	-	
Reverse Transfer Capacitance	C_{rss}		-	20	-	
Gate Resistance	R_g	f = 1MHz	-	1.1	-	Ω
Switching Characteristics⁵						
Total Gate Charge	Q_g	V _{GS} = 10V, V _{DS} = 60V, I _D = 10A	-	23	-	nC
Gate-Source Charge	Q_{gs}		-	3.5	-	
Gate-Drain Charge	Q_{gd}		-	5	-	
Turn-On Delay Time	t_{d(on)}	V _{GS} = 10V, V _{DD} = 60V, R _G = 3Ω, I _D = 10A	-	10.8	-	ns
Rise Time	t_r		-	5.2	-	
Turn-Off Delay Time	t_{d(off)}		-	32.6	-	
Fall Time	t_f		-	5.8	-	
Drain-Source Body Diode Characteristics						
Diode Forward Voltage ⁴	V_{SD}	I _S = 10A, V _{GS} = 0V	-	-	1.2	V
Continuous Source Current	T _C =25°C I_S	-	-	-	14.5	A

Notes:

1. Repetitive rating, pulse width limited by junction temperature T_{J(MAX)}=150°C.
2. The EAS data shows Max. rating . The test condition is V_{DD}=25V, V_{GS}=10V, L=0.4mH, I_{AS}=10A.
3. The data tested by surface mounted on a 1 inch² FR-4 board with 2OZ copper, The value in any given application depends on the user's specific board design.
4. The data tested by pulsed , pulse width ≤ 300us , duty cycle ≤ 2%.
5. This value is guaranteed by design hence it is not included in the production test.

Typical Characteristics

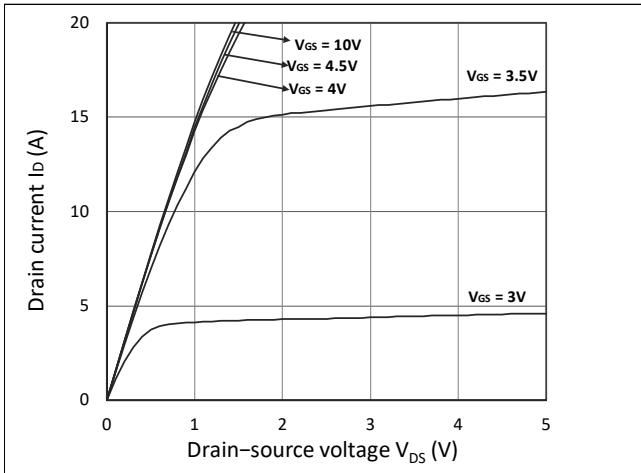

Figure 1. Output Characteristics

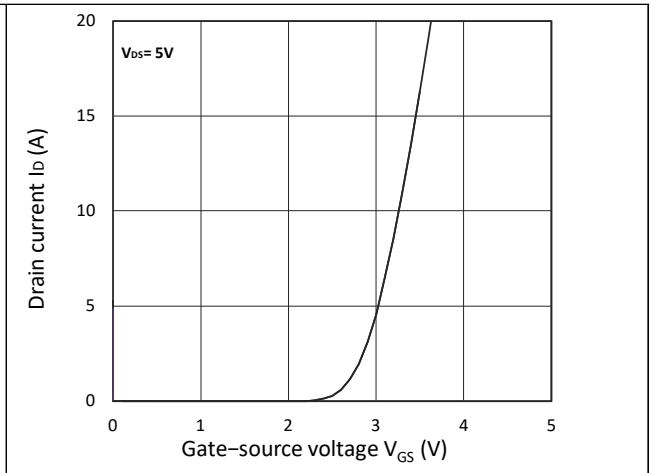

Figure 2. Transfer Characteristics

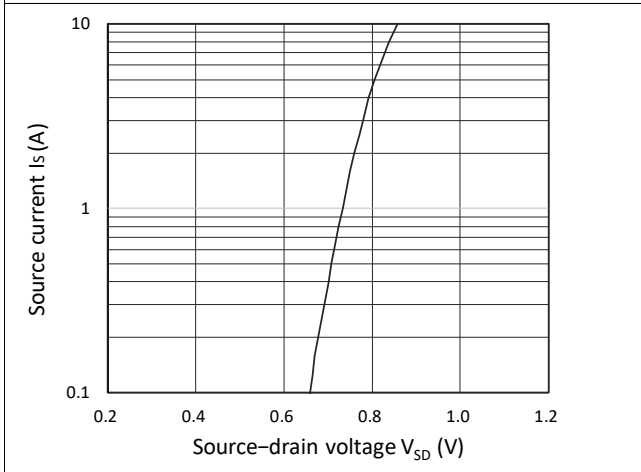

Figure 3. Forward Characteristics of Reverse

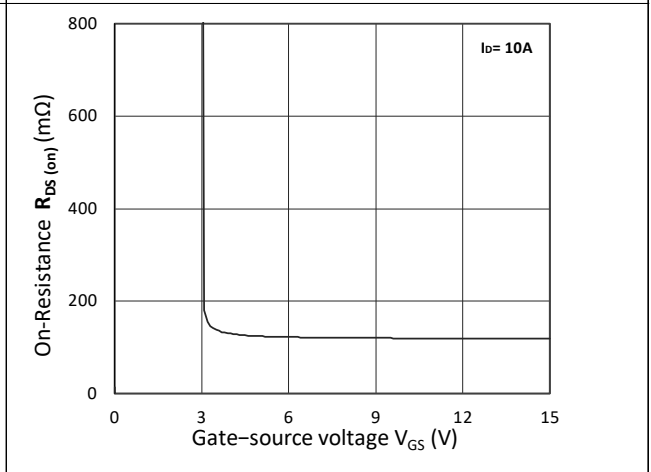

Figure 4. $R_{DS(ON)}$ vs. V_{GS}

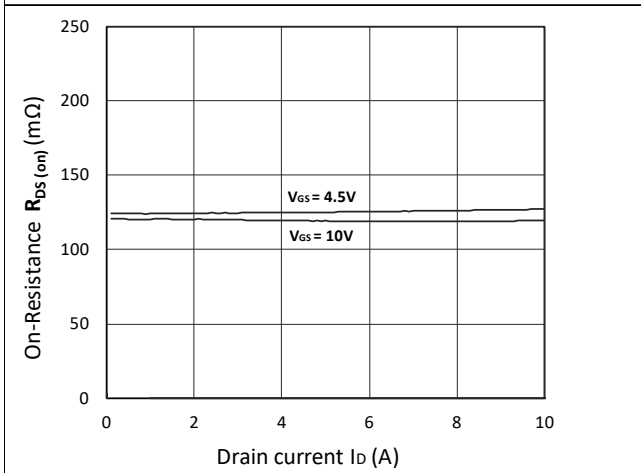

Figure 5. $R_{DS(ON)}$ vs. I_D

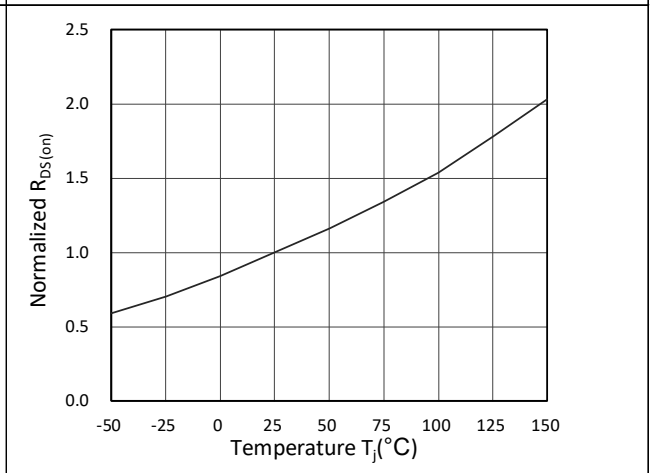

Figure 6. Normalized $R_{DS(ON)}$ vs. Temperature

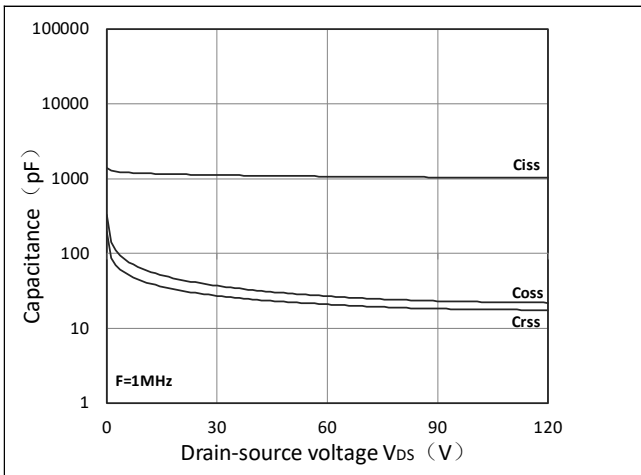

Figure 7. Capacitance Characteristics

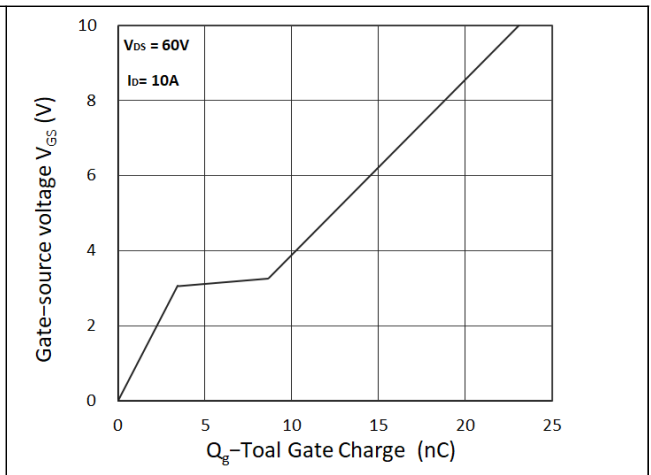

Figure 8. Gate Charge Characteristics

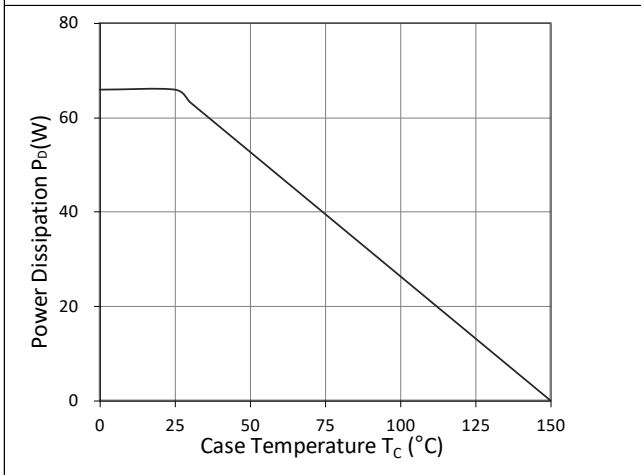

Figure 9. Power Dissipation

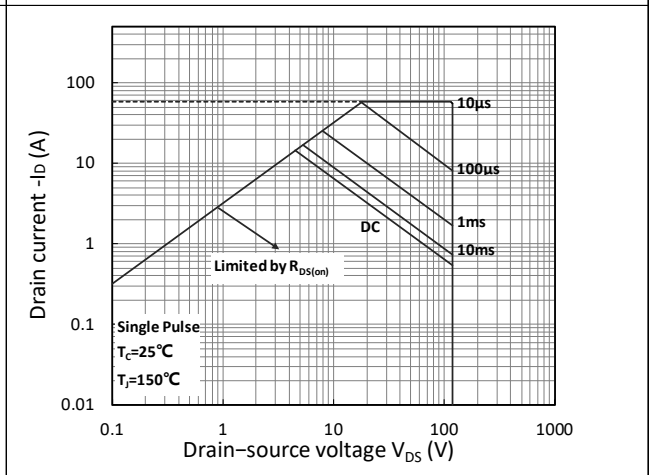

Figure 10. Safe Operating Area

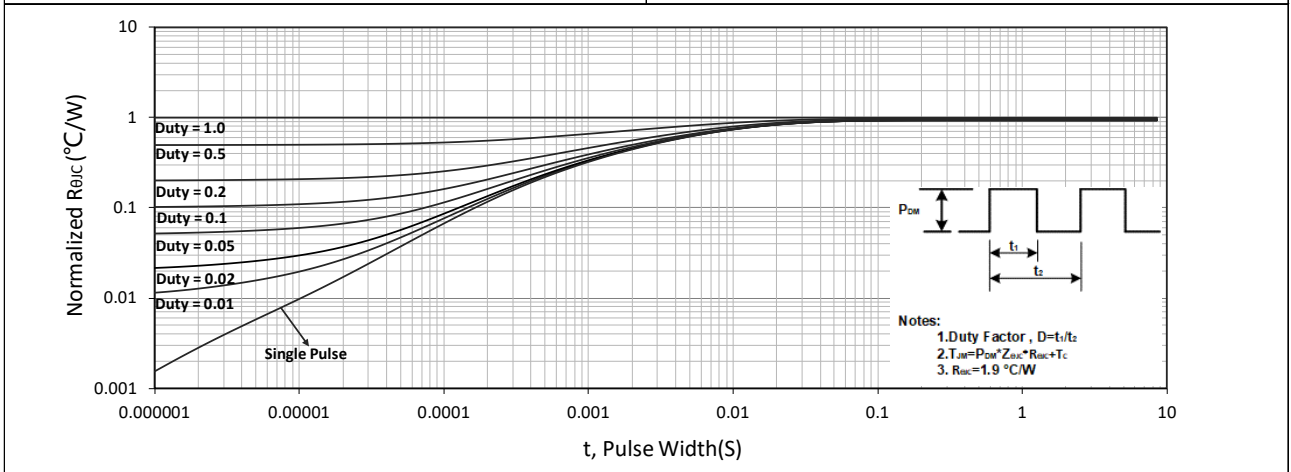

Figure 11. Normalized Maximum Transient Thermal Impedance

Test Circuit

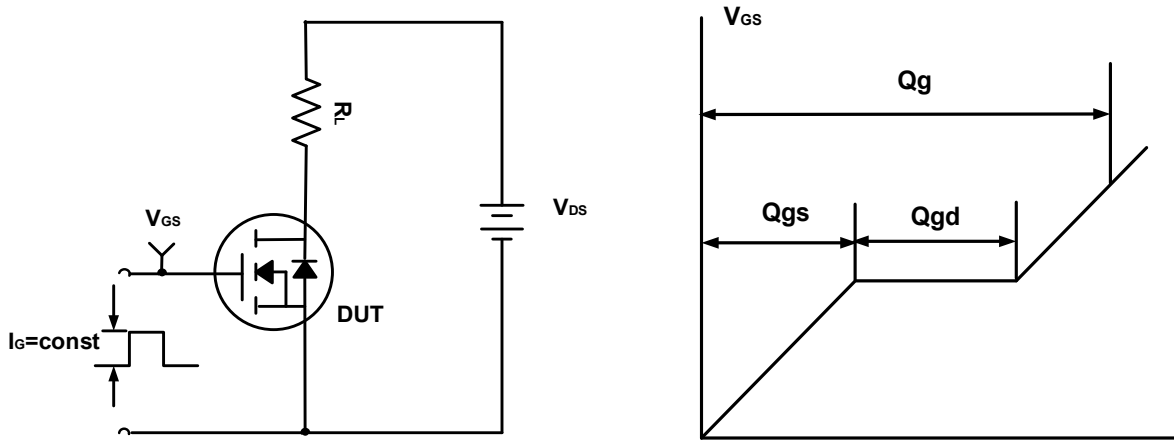

Figure A. Gate Charge Test Circuit & Waveforms

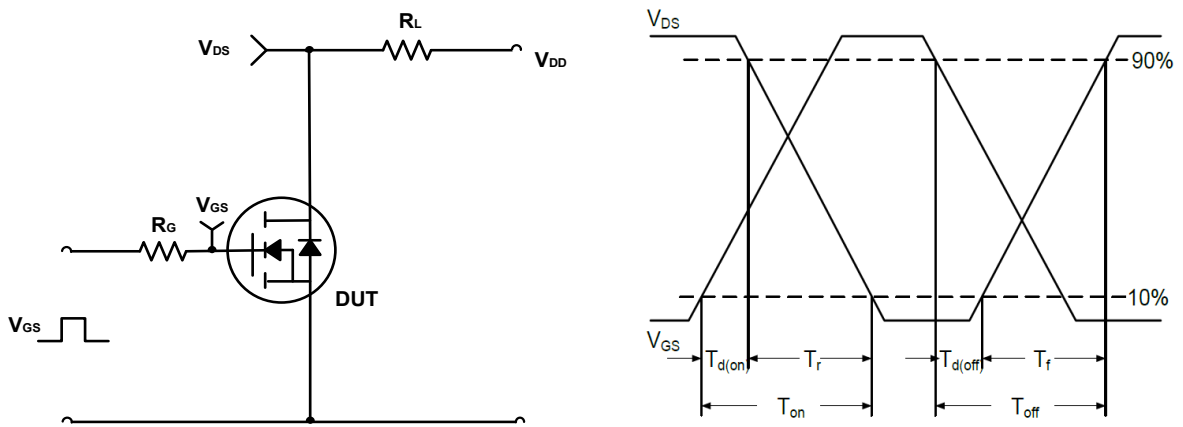

Figure B. Switching Test Circuit & Waveforms

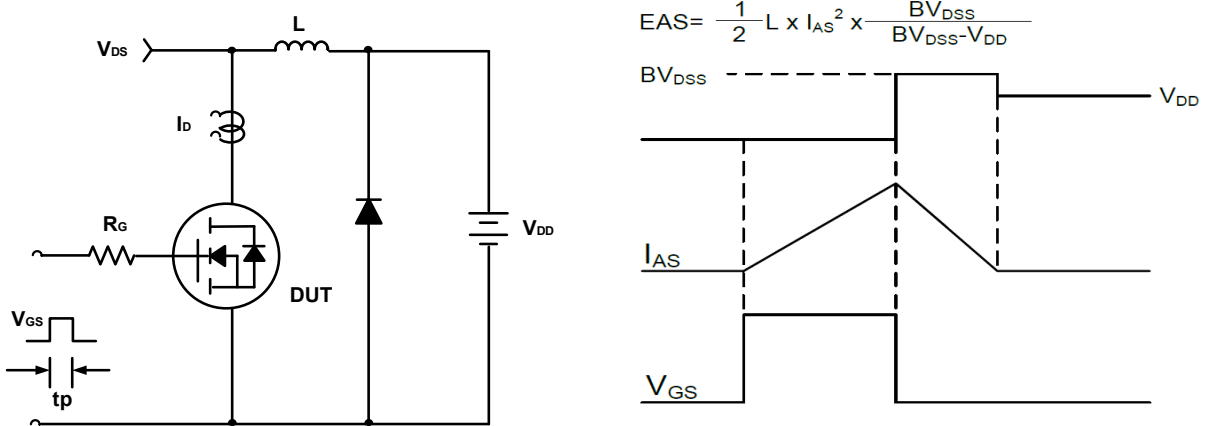
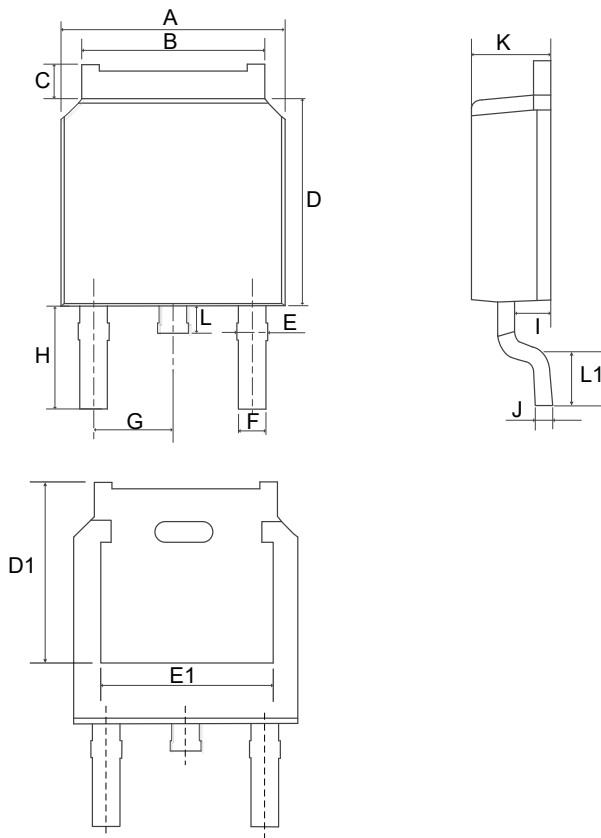

Figure C. Unclamped Inductive Switching Circuit & Waveforms

Mechanical Dimensions for TO-252



COMMON DIMENSIONS

SYMBOL	MM	
	MIN	MAX
A	6.40	6.80
B	5.13	5.50
C	0.88	1.28
D	5.90	6.22
D1	5.35REF	
E	0.68	1.10
E1	4.83REF	
F	0.68	0.91
G	2.29REF	
H	2.90REF	
I	0.85	1.17
J	0.51REF	
K	2.10	2.50
L	0.40	1.00
L1	1.50REF	

Ordering Information

Part	Package	Marking	Packing method
WMO15N12TS	TO-252	WMO15N12TS	Tape and Reel

Marking Information

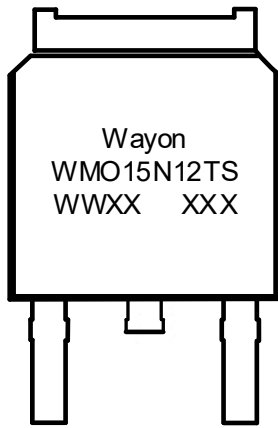

WMO15N12TS= Device code

WWXX XXX= Date code

Contact Information

No.1001, Shiwan(7) Road, Pudong District, Shanghai, P.R.China.201207

Tel: 86-21-50310888 Fax: 86-21-50757680 Email: market@way-on.com

WAYON website: <http://www.way-on.com>

For additional information, please contact your local Sales Representative.

 © is registered trademarks of Wayon Corporation.

Disclaimer

WAYON reserves the right to make changes without further notice to any Products herein to improve reliability, function, or design. The Products are not designed for use in hostile environments, including, without limitation, aircraft, nuclear power generation, medical appliances, and devices or systems in which malfunction of any Product can reasonably be expected to result in a personal injury. The information given in this document shall in no event be regarded as a guarantee of conditions or characteristics. WAYON does not assume any liability for infringement of patents, copyrights, or other intellectual property rights of third parties by or arising from the use of Products or technical information described in this document.